

BLACK DIAMOND PERFORMANCE - BRAKE PAD SHAPE GUIDE

PP001

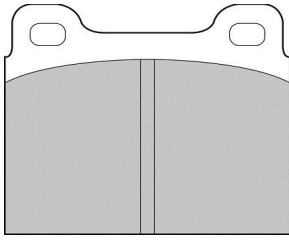

62 x 56 x 15mm

Alfa Romeo, Mercedes, Porsche, Volvo

PP003

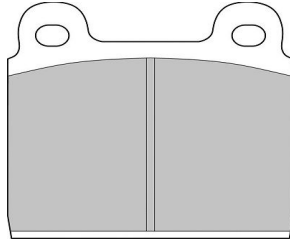

77 x 70 x 15mm

Alfa Romeo, Porsche, Volkswagen

PP004

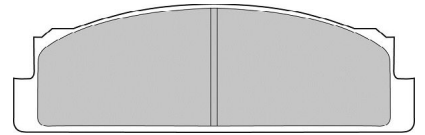

109 x 39 x 10mm

Autobianchi, Fiat, FSO

PP005

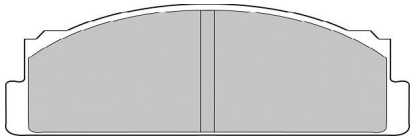

109 x 39 x 17.5mm

Autobianchi, Fiat, FSO, Yugo

PP006

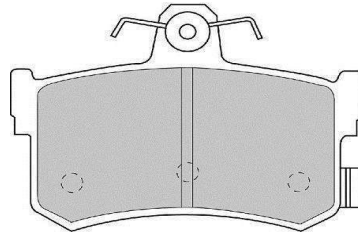

85 x 63 x 14.5mm

MG, Rover

PP008

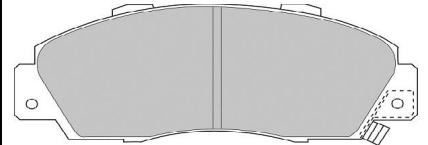

149 x 57 x 18.5mm

Honda, Rover

PP018

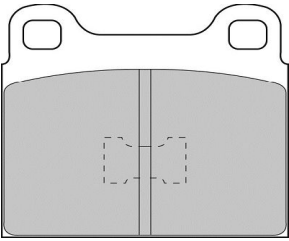

62 x 57 x 15mm

Audi, Volkswagen

PP020

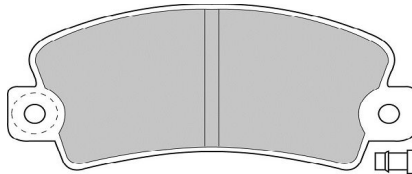

109 x 49 x 15mm

Citroën, Peugeot, Renault, Talbot

PP021

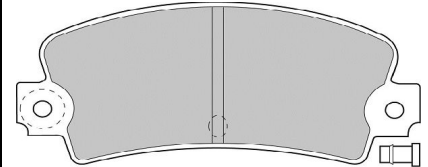

109 x 49 x 14mm

Lotus, Renault

PP022

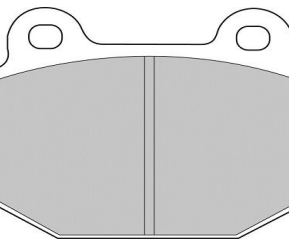

77 x 65 x 16mm

Alfa Romeo

PP033

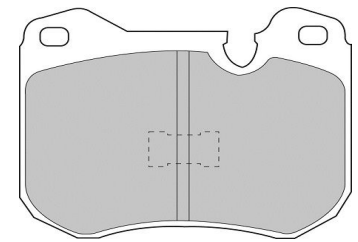

90 x 72 x 19mm

Porsche

PP034

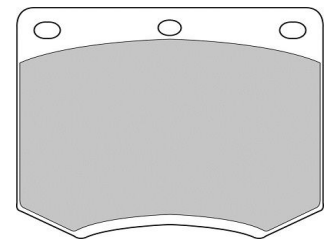

78 x 67 x 15mm

Ford, Hyundai, Lotus, Triumph, TVR

PP035

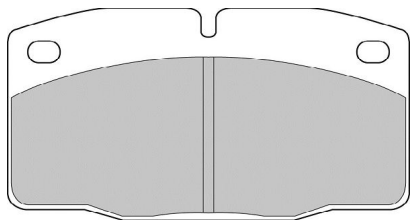

100 x 59 x 15.5mm

Lotus, Vauxhall/Opel

PP036

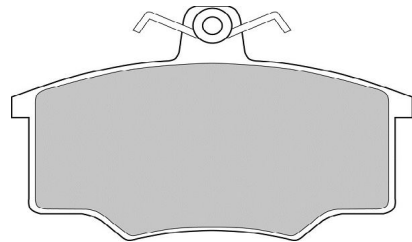

104 x 67 x 19mm

Audi, Volvo

PP039

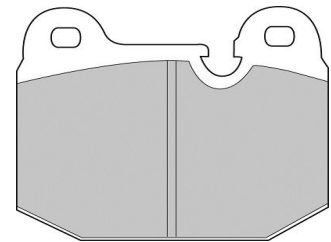

77 x 65 x 16mm

BMW

BRAKE PADS

PP040

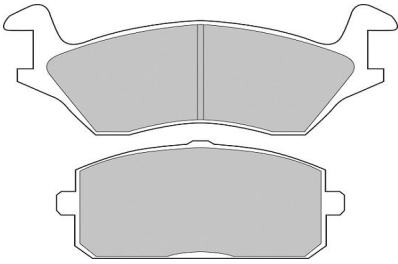

132/98 x 49/44 13.5mm

Toyota

PP044

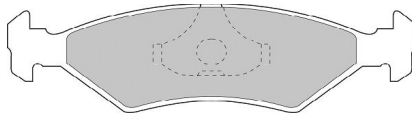

151 x 47 x 17.5mm

Ford, TVR, Westfield

PP045

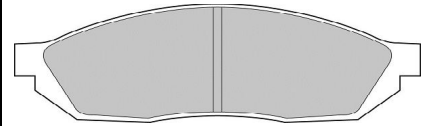

119 x 39 x 15mm

Triumph, Suzuki, Vauxhall

PP047

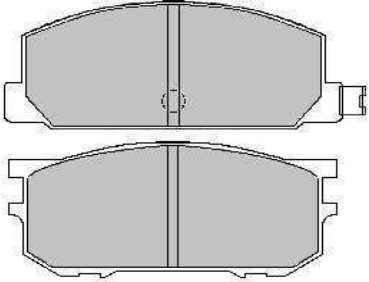

106/109 x 52/49 x 14mm

Daihatsu, Toyota

PP048

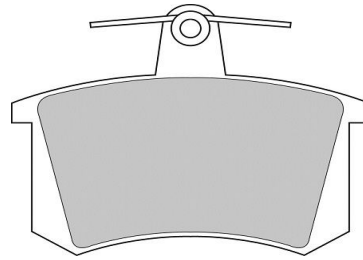

88 x 68 x 16mm

Alfa Romeo, Audi, Fiat, Lancia

PP049

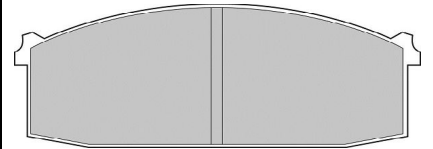

112 x 44 x 14.5mm

Nissan

PP052

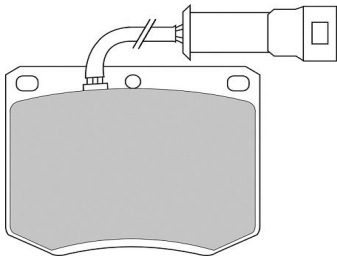

98 x 64 x 15mm

Ford

PP054

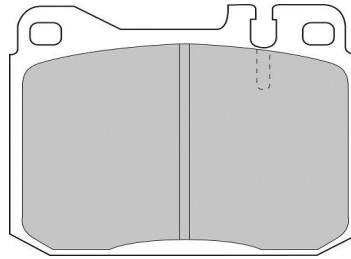

90 x 74 x 17.5mm

Mercedes

PP057

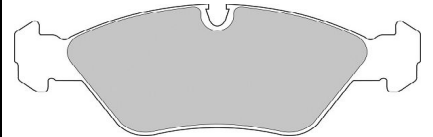

158 x 57 x 20mm

Alpina, BMW, Porsche

PP059

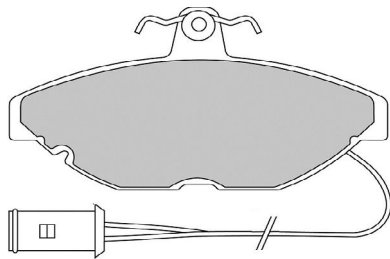

118 x 64 x 17.5mm

Reliant, Rover Group

PP060

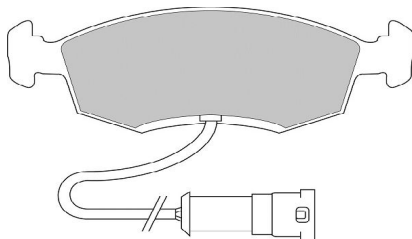

151 x 49 x 18mm

AC, Ford

PP063

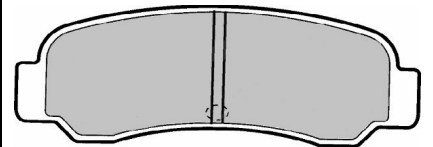

99 x 37 x 15mm

Toyota

PP064

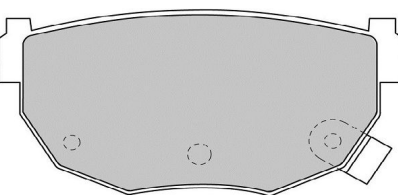

85 x 42 x 15mm

Nissan

PP065

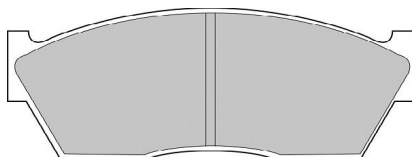

116 x 54 x 15mm

Honda

PP066



116 x 54 x 15mm

Mitsubishi

BRAKE PADS

PP067

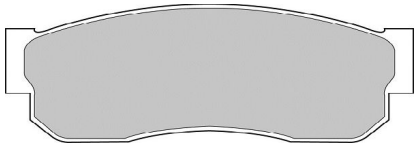

109 x 40 x 16mm
Nissan, Subaru

PP069

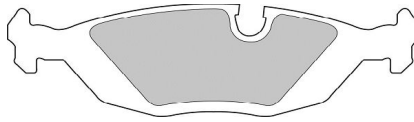

126 x 39 x 16mm
Alpina, BMW

PP075



119 x 48 x 15mm
Toyota

PP076

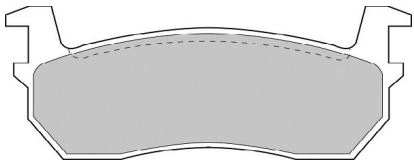

108 x 46 x 15.5mm
Nissan

PP079

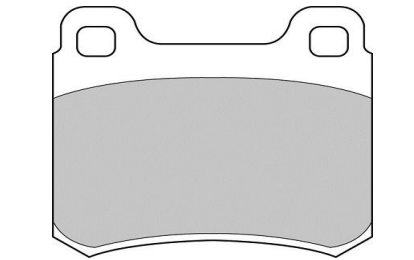

62 x 55 x 13.5mm
Mercedes

PP080

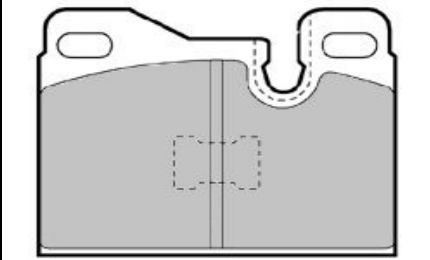

78 x 59 x 18.5mm
Porsche

PP081

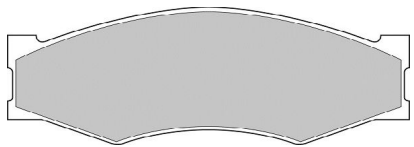

130 x 50 x 16mm
Nissan

PP086

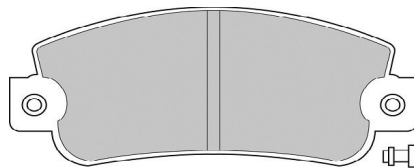

109 x 47 x 18mm
Autobianchi, Fiat, Lancia, Seat

PP090

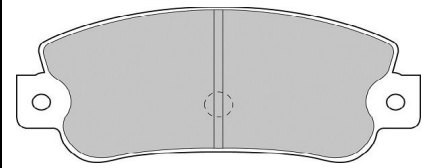

109 x 47 x 12mm
Fiat, Lancia

PP091

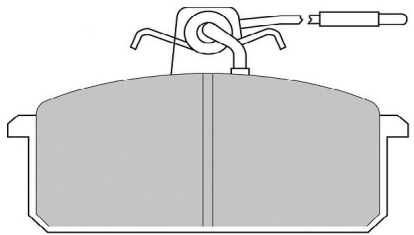

99 x 63 x 16mm
Autobianchi, Lancia, Seat

PP092

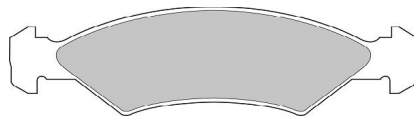

141 x 42 x 18mm
Ford

PP093

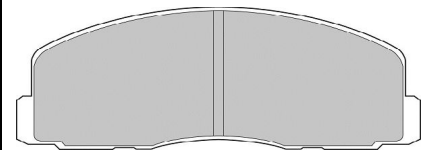

128 x 52 x 15mm
Mitsubishi

PP094

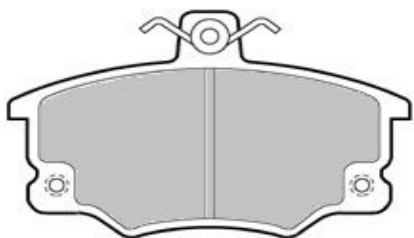

104 x 67 x 17mm
Alfa Romeo, Fiat, Lancia

PP096

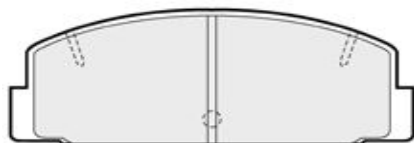

108 x 39 x 13mm
Mazda

PP097

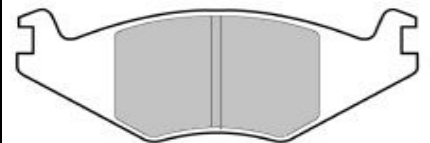

138 x 51 x 17mm
Seat, Volkswagen

BRAKE PADS

PP098

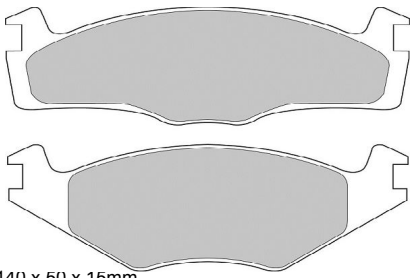

140 x 50 x 15mm
Seat, Volkswagen

PP099

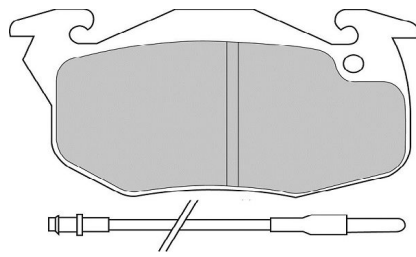

105 x 55 x 18mm
Citroën, Peugeot, Renault

PP100

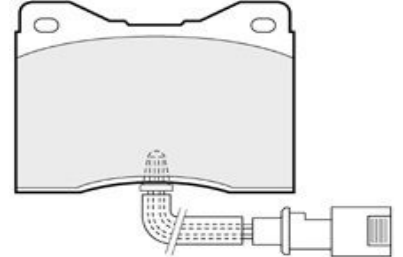

89.5 x 71 x 16.5mm
BMW, Ford

PP102

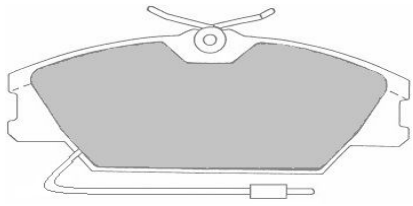

130 x 55 x 18.5mm
Renault

PP104

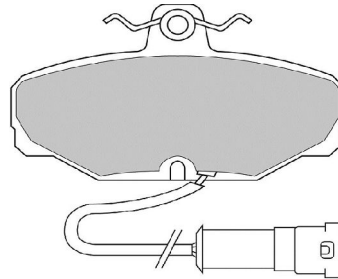

90 x 54 x 13.5mm
AC, Ford, TVR

PP105

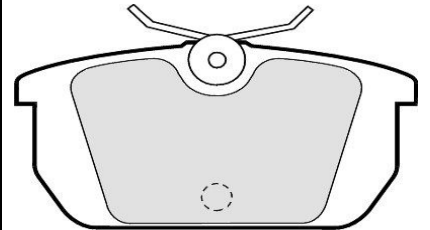

88 x 44 x 14.5mm
Alfa Romeo, Fiat, Lancia

PP106

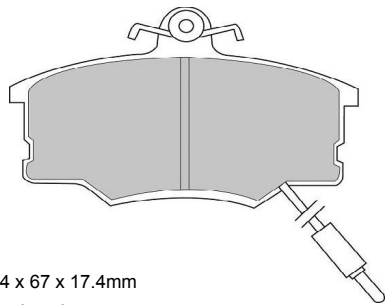

104 x 67 x 17.4mm
Fiat, Lancia

PP109

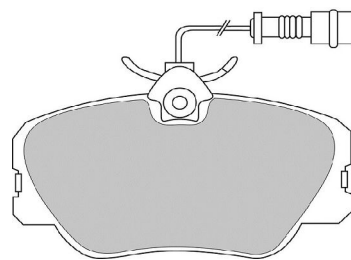

108 x 60 x 19mm
Mercedes

PP112

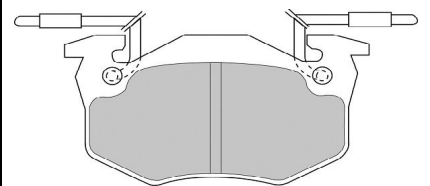

105 x 56 x 17.7mm
Citroën, Renault

PP113

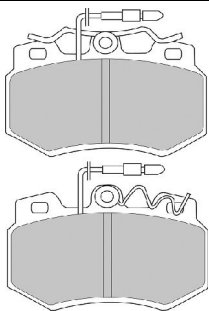

90 x 63 x 17mm
Citroën

PP114

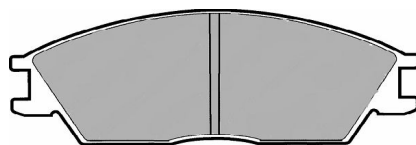

127 x 50 x 15mm
Honda, Hyundai

PP120

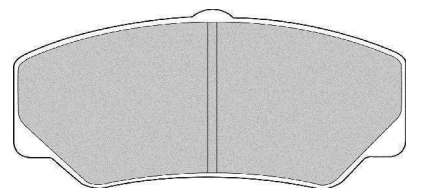

117 x 58 x 19mm
Ford

PP123

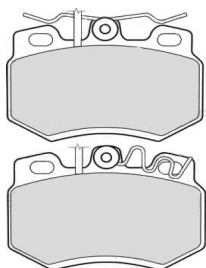

90 x 63 x 18mm
Peugeot

PP124

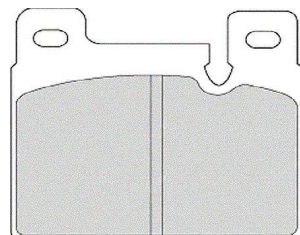

77 x 70 x 15mm
Porsche

PP127

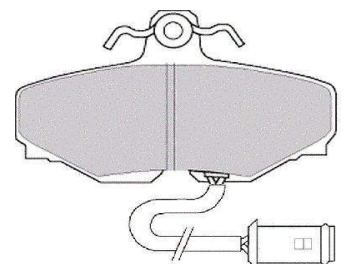

115 x 80 x 17mm
Jaguar

BRAKE PADS

PP129

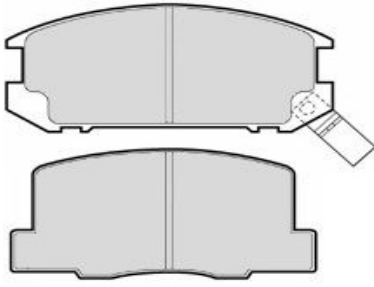

98/107 x 47 x 15/16mm

Toyota

PP130

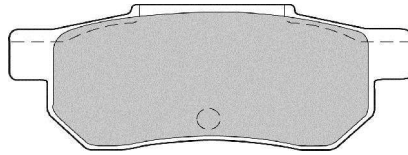

89 x 36 x 13mm

Honda

PP133

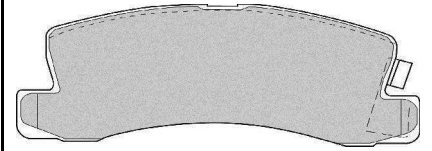

108 x 43 x 15mm

Lexus, Toyota

PP134

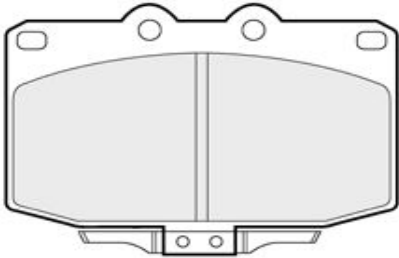

106.5 x 76.5 x 14mm

Mazda

PP138

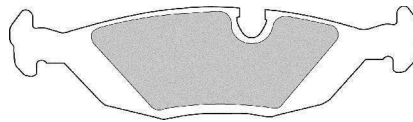

126 x 39 x 15mm

Saab, Volvo

PP141

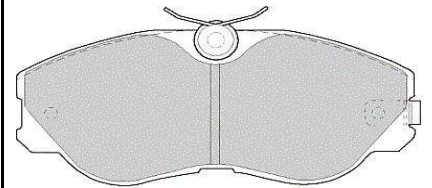

137 x 60 x 17mm

Nissan

PP142

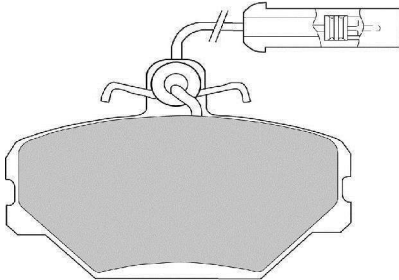

90 x 65 x 17mm

Fiat, FSO, Lancia

PP144

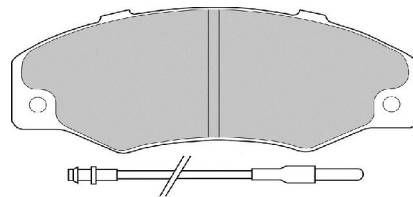

123 x 48 x 17mm

Renault

PP145

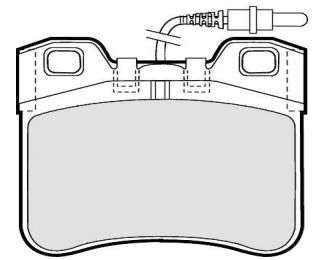

72 x 59 x 17mm

Citroën, Peugeot

PP147

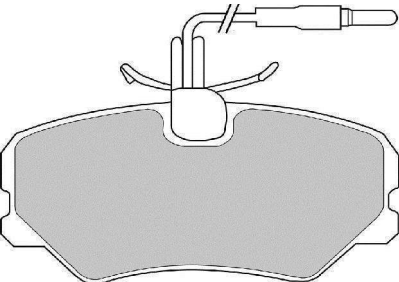

95 x 49 x 19mm

Citroën, Peugeot

PP148

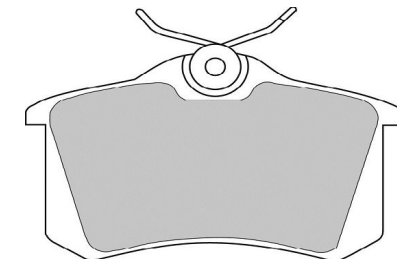

87 x 53 x 15mm

Citroën, Ford, Peugeot, Renault, VAG

PP149

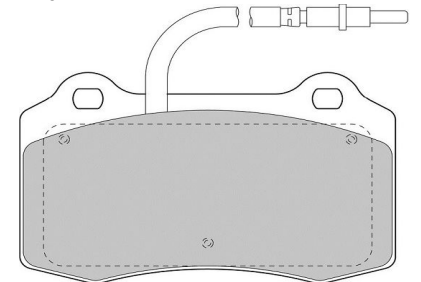

110 x 70 x 17.7mm

Peugeot

PP150

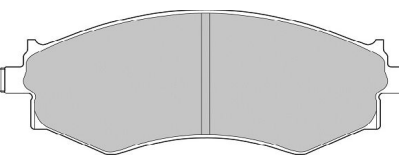

137 x 54 x 17mm

Hyundai, Kia

PP151

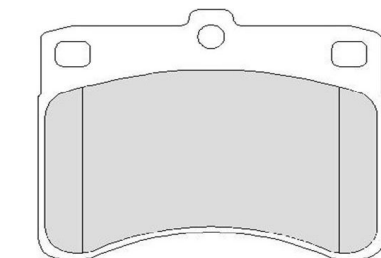

79 x 63 x 13mm

Daihatsu, Perodua, Piaggio

PP153

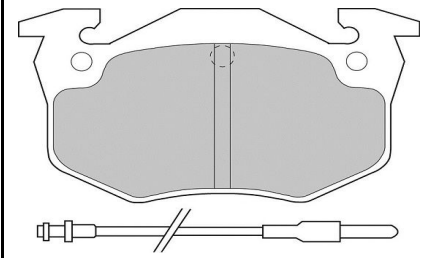

105 x 55 x 11mm

Citroën, Peugeot, Renault

BRAKE PADS

PP154

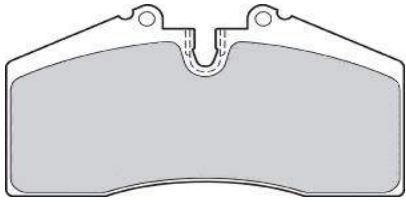

132 x 71 x 17mm
Audi, Porsche

PP155

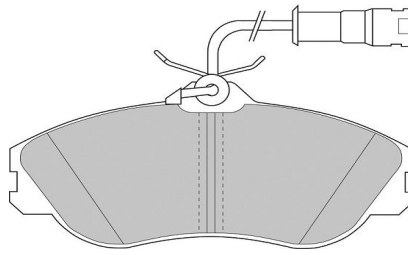

145 x 71 x 19mm
Audi

PP156

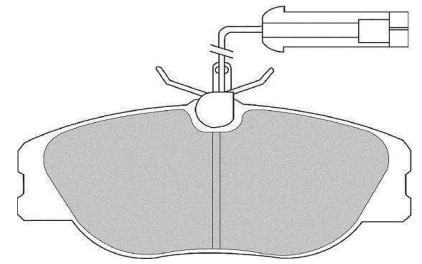

130 x 59 x 19mm
Alfa Romeo, Fiat, Lancia

PP158

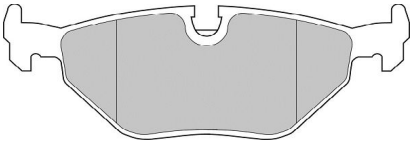

122 x 45 x 16mm
BMW

PP160

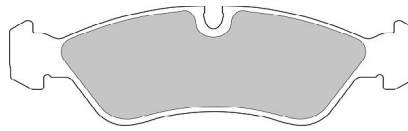

156 x 51 x 17.5mm
Daewoo, Vauxhall

PP161

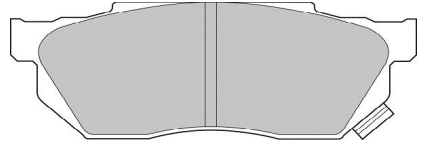

116 x 45 x 15mm
Honda

PP162

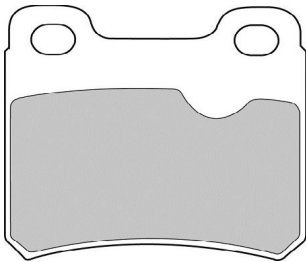

62 x 58 x 15.5mm
Saab, Vauxhall

PP163

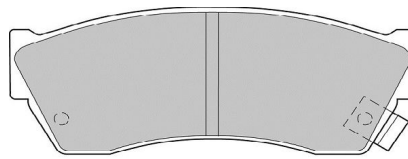

108 x 45 x 15mm
Subaru, Suzuki

PP164

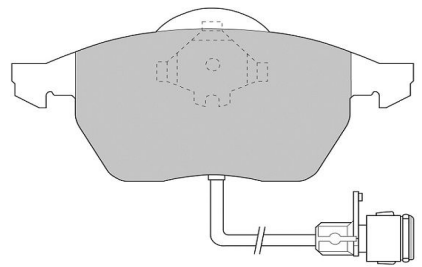

157 x 75 x 19.5mm
Audi, Volkswagen

PP165

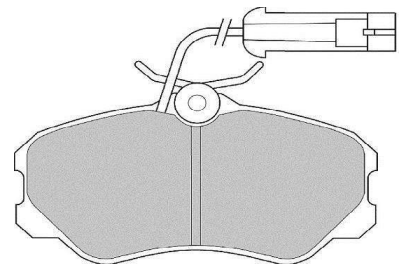

110 x 58 x 19mm
Alfa Romeo, Fiat, Lancia

PP166

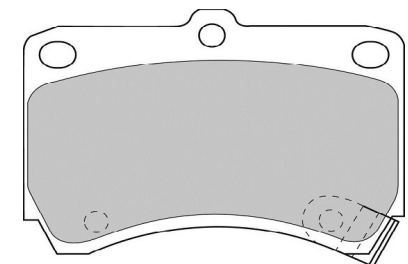

79 x 63 x 14mm
Kia, Mazda

PP167

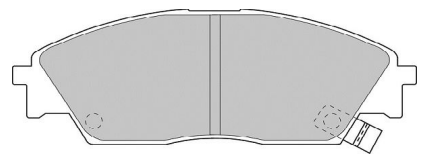

132 x 49 x 15mm
Honda

PP168

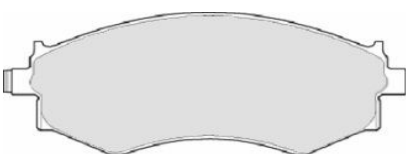

137 x 54 x 17mm
Hyundai, Nissan

PP169



120 x 53.5 x 15mm
Toyota

PP170

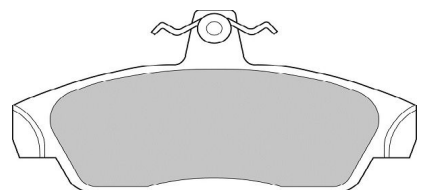

115 x 58 x 15mm
MG, Rover Group

BRAKE PADS

PP171

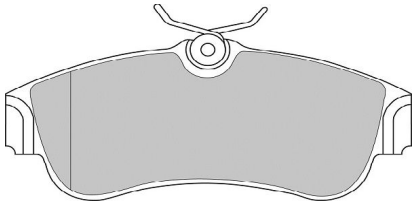

129 x 56 x 16.5mm

Nissan

PP172

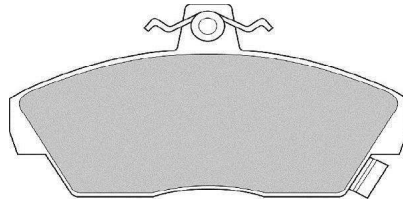

118 x 65 x 18mm

Rover Group

PP174

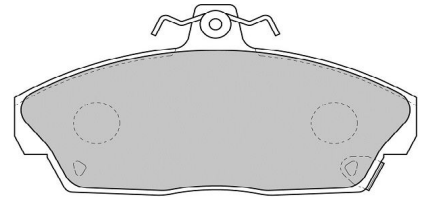

129 x 69 x 17.5mm

Honda, Land Rover, MG, Rover

PP175

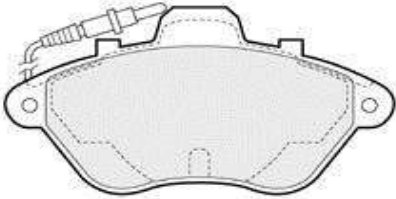

131 x 68.5 x 16.5mm

Citroën, Peugeot

PP176

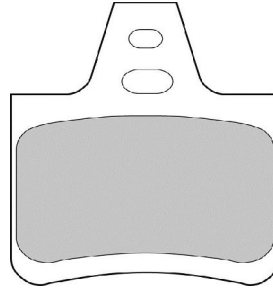

54 x 65 x 15mm

Citroën

PP177

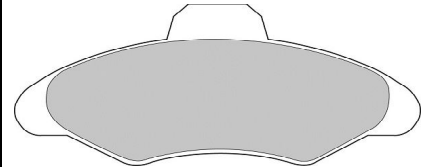

131 x 58 x 19mm

Ford

PP178

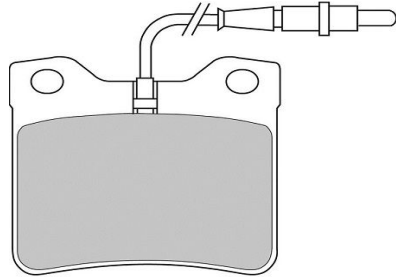

64 x 57 x 17mm

Peugeot

PP179

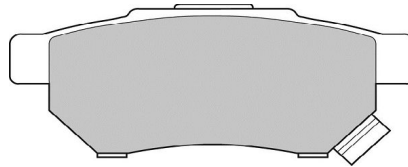

89 x 35 x 13mm

Honda, MG, Rover Group

PP180

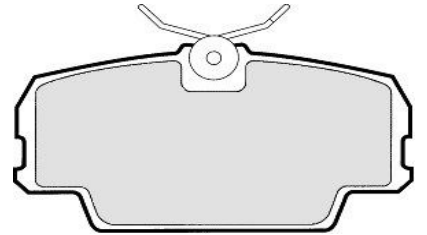

95 x 52 x 17mm

Saab, Volvo

PP182

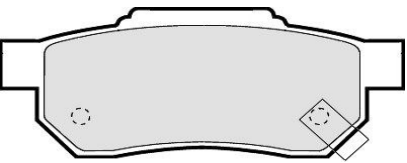

89 x 35 x 13mm

Honda

PP186

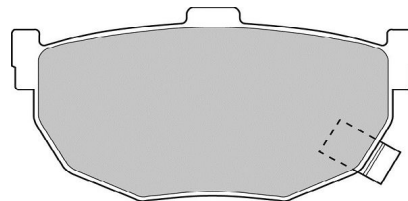

86 x 46 x 14mm

Hyundai, Kia, Nissan

PP187

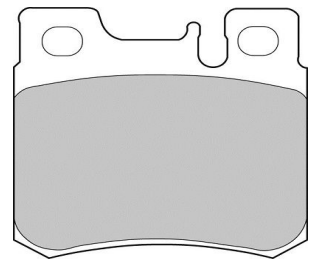

62 x 59 x 15.5mm

Mercedes

PP189

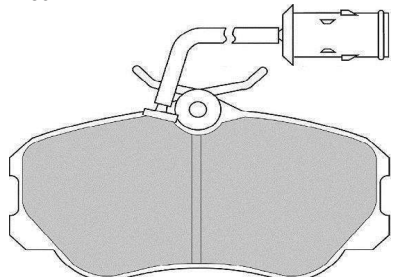

110 x 58 x 19mm

Alfa Romeo

PP190

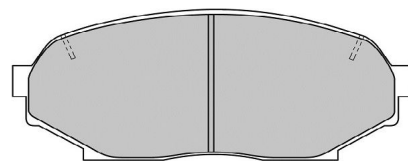

110 x 46 x 14mm

Mazda

PP191

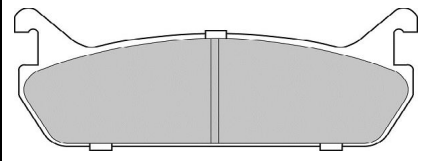

100 x 39 x 12.5mm

Daihatsu, Mazda, Suzuki

BRAKE PADS

PP192

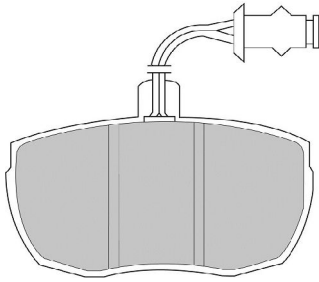

105 x 75 x 18mm
Land Rover

PP193

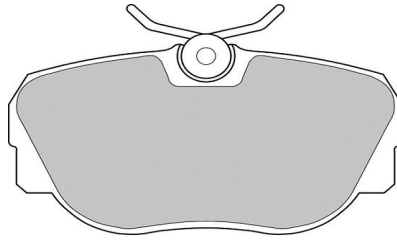

95 x 55 x 17mm
BMW

PP194

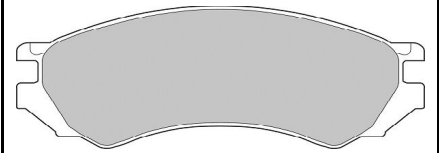

128 x 50 x 16mm
Nissan

PP195

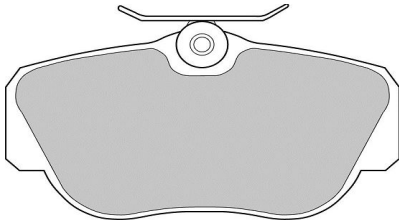

95 x 54 x 18mm
Mercedes

PP196

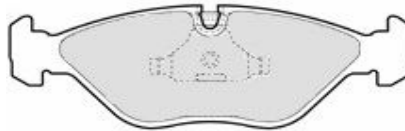

156 x 55 x 19.5mm
Saab

PP197

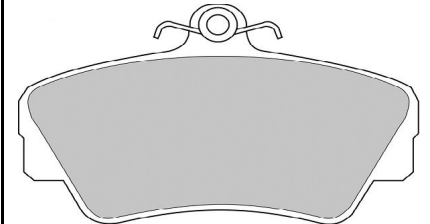

110 x 69 x 17.5mm
Volvo

PP198

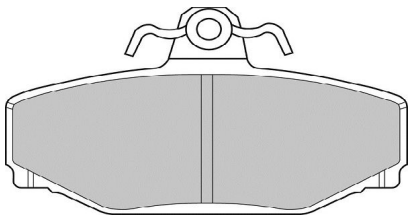

90 x 54 x 13mm
Volvo

PP200

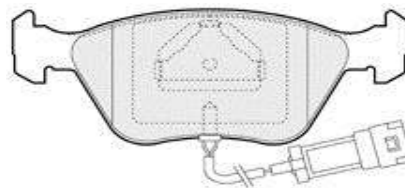

156 x 56 x 19mm
Ford

PP201

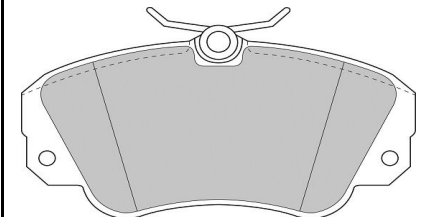

130 x 64 x 19mm
Vauxhall

PP202

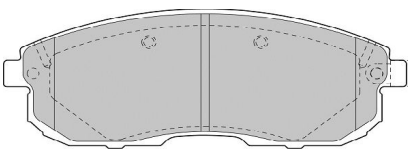

137 x 53 x 17mm
Nissan

PP203

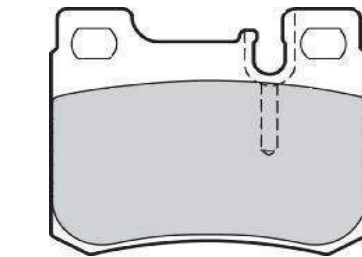

62 x 54 x 15mm
Mercedes

PP206

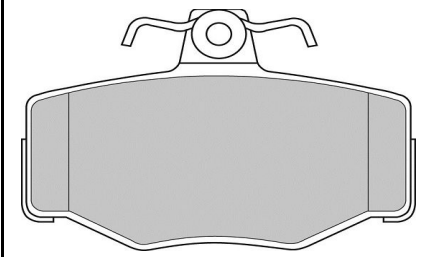

82 x 57 x 15.5mm
Nissan

PP208

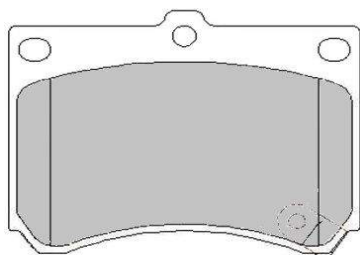

92 x 71 x 15mm
Mazda

PP209

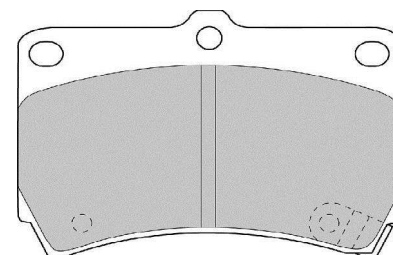

92 x 64 x 15mm
Kia, Mazda

PP210

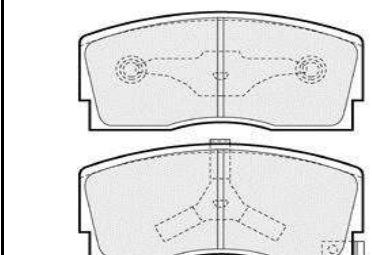

103 x 47 x 14mm
Daihatsu

BRAKE PADS

PP212

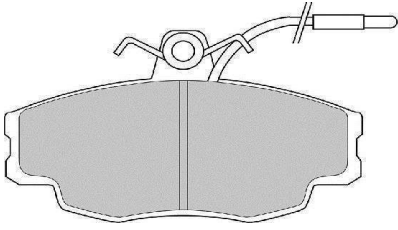

100 x 63 x 18mm

Citroën, Peugeot, Renault

PP214

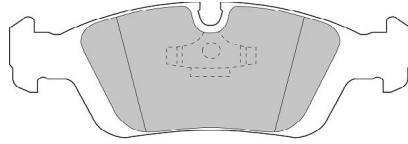

151 x 57 x 16.5mm

BMW

PP216

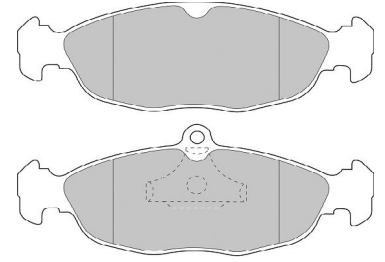

140 x 59/49 x 16.5mm

Daewoo, Jaguar, Vauxhall

PP217

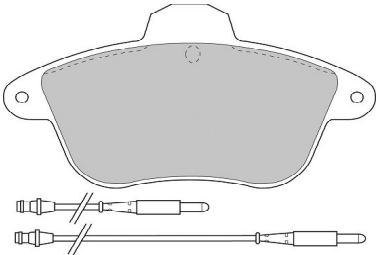

131 x 73 x 17mm

Citroën

PP218

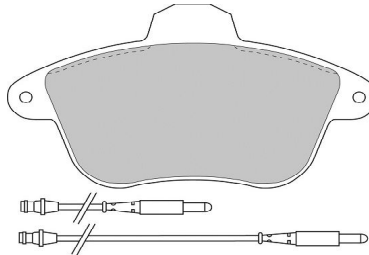

131 x 73 x 17mm

Peugeot

PP219

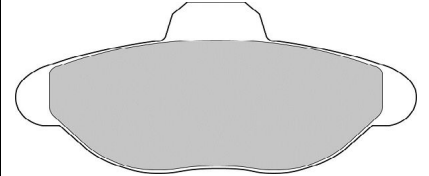

115 x 54 x 17mm

Fiat, Lancia

PP220

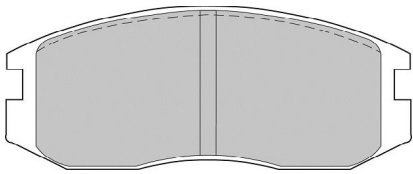

115 x 50 x 15mm

Daihatsu, Mitsubishi, Proton

PP221

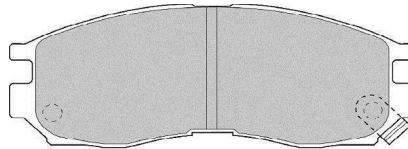

128 x 50 x 16mm

Mitsubishi, Proton

PP222

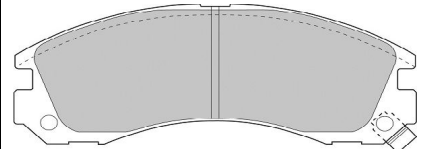

150 x 59 x 16mm

Citroën, Mitsubishi, Peugeot

PP223

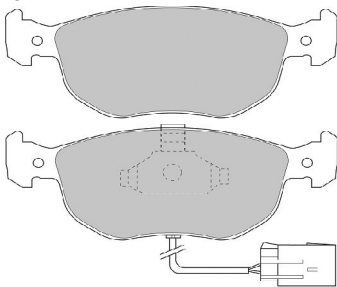

156 x 60 x 19mm

AC, Ford

PP225

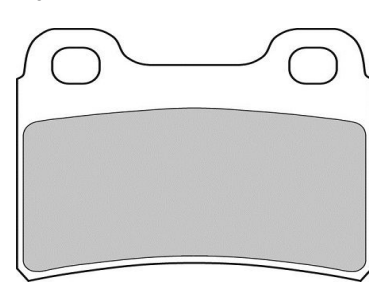

62 x 50 x 15mm

Ford, Kia

PP226

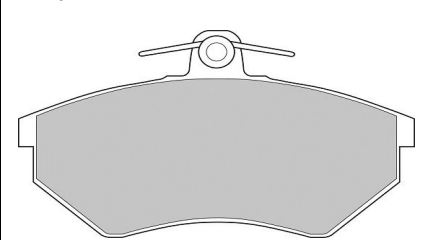

119 x 70 x 16mm

Audi, Seat, Volkswagen

PP227

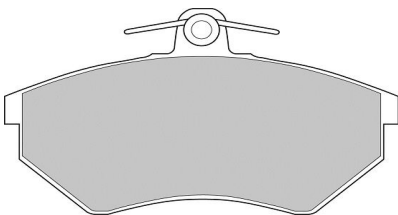

119 x 70 x 19mm

Audi, Seat, Volkswagen

PP228

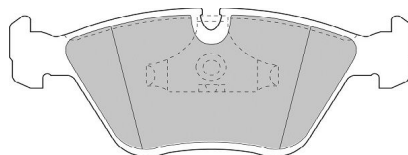

156 x 62 x 19mm

BMW

PP229

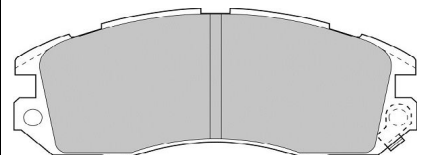

128 x 54 x 17mm

Subaru

BRAKE PADS

PP230

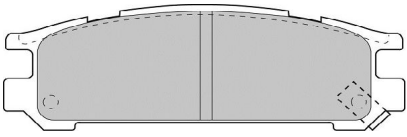

108 x 38 x 15mm
Subaru

PP231

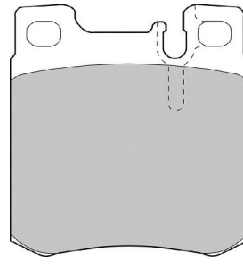

62 x 72 x 16mm
Mercedes

PP232

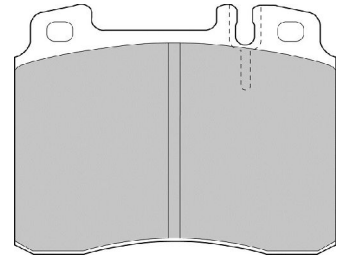

100 x 86 x 18.5mm
Mercedes

PP233

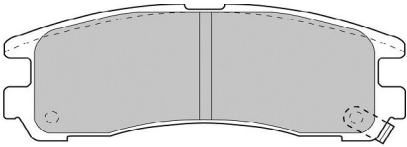

108 x 41 x 15.5mm
Mitsubishi

PP234

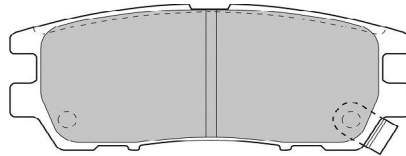

107 x 44 x 15.5mm
Mitsubishi

PP235

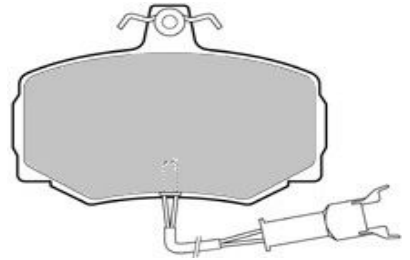

115 x 80 x 17mm
Jaguar

PP237

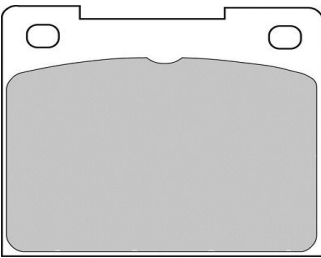

64 x 55 x 14.3mm
Caterham, Lotus, Triumph, Volvo

PP238

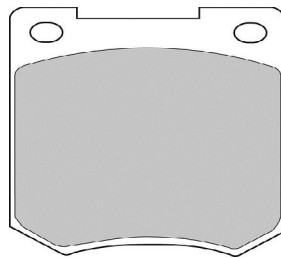

64 x 64 x 14.3mm
Austin, Ford, Talbot Group

PP240

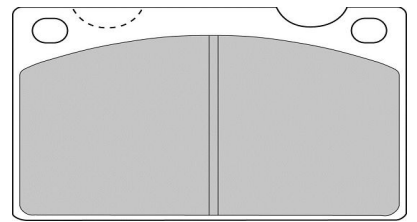

98 x 60 x 16mm
Volvo

PP241

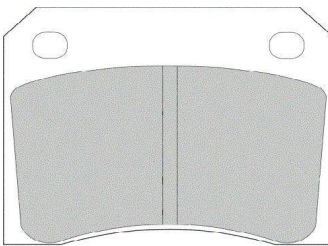

81 x 66 x 16mm
Jaguar

PP242

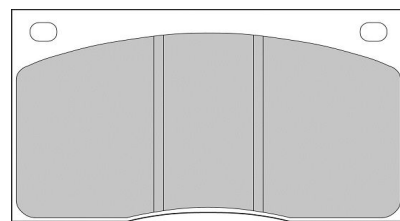

120 x 71 x 15mm
Aston Martin, Jaguar

PP243

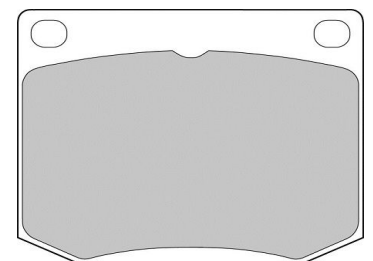

78 x 64 x 15mm
Ford, Triumph, Saab

PP244

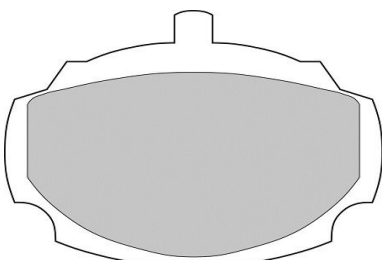

88 x 64 x 15mm
MG

PP245

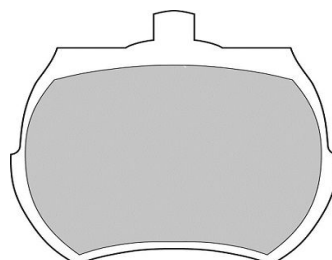

74 x 64 x 13.5mm
Austin, Austin Healey, Innocenti, MG

PP251

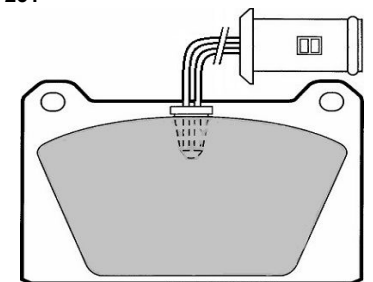

84 x 55 x 14.5mm
Austin, MG, Reliant

BRAKE PADS

PP252

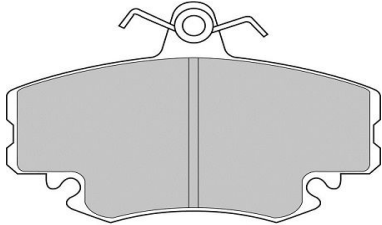

100 x 65 x 18mm
Dacia, Renault

PP253

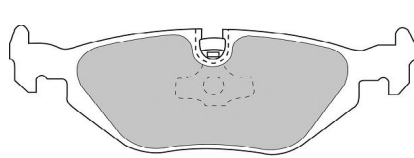

123 x 43.5 x 16.7mm
BMW

PP254

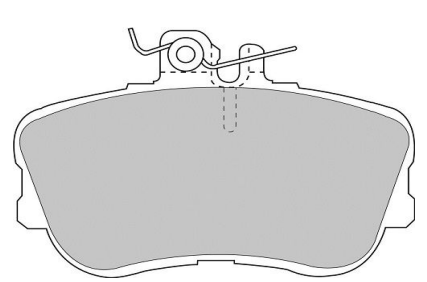

109 x 75 x 19.5mm
Mercedes

PP256

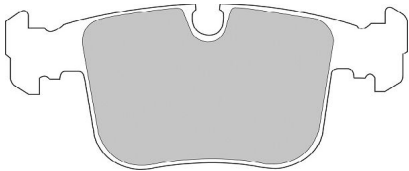

156.5 x 75 x 19.3mm
BMW

PP257

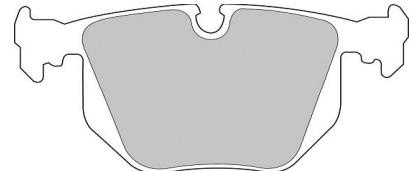

123 x 59 x 17mm
BMW

PP258

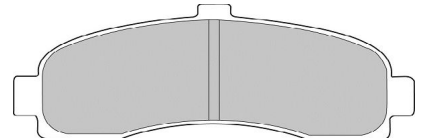

121 x 45 x 15mm
Nissan

PP259

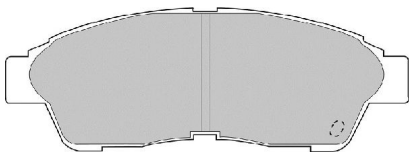

133 x 53 x 17mm
Toyota

PP260

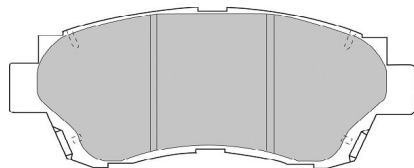

141 x 62.5 x 16.5mm
Lexus, Toyota

PP261

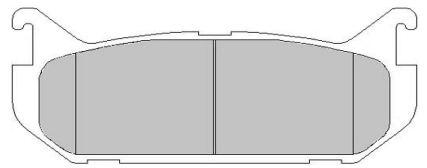

100 x 43.5 x 14.7mm
Ford, Mazda

PP262

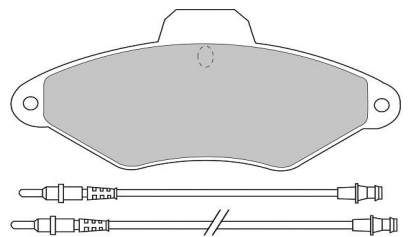

131 x 60 x 17mm
Citroën

PP263

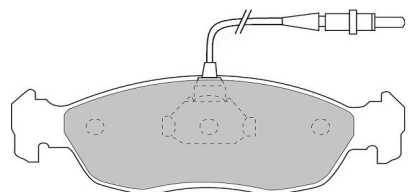

141 x 47.8 x 17.5mm
Citroën, Peugeot

PP264

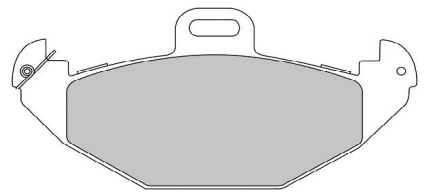

126 x 63 x 15mm
Renault

PP266

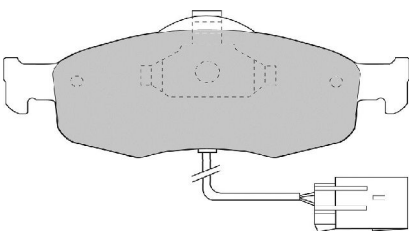

155 x 59 x 18mm
Ford

PP267

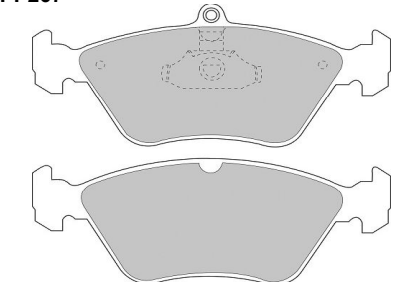

156 x 71/61 x 17.5mm
Saab, Vauxhall

PP268

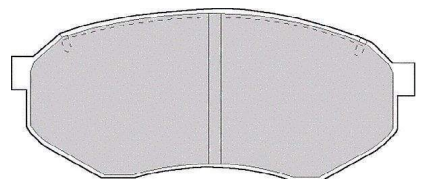

116 x 55 x 15mm
Mazda

BRAKE PADS

PP270

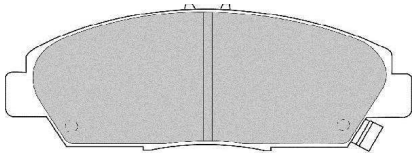

138 x 54 x 18.5mm
Honda, Rover

PP271

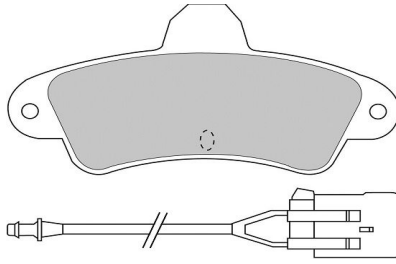

116 x 54 x 15mm
Ford

PP272

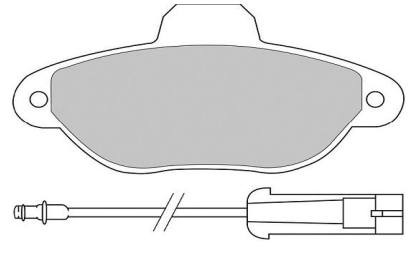

115 x 55 x 17mm
Fiat

PP273

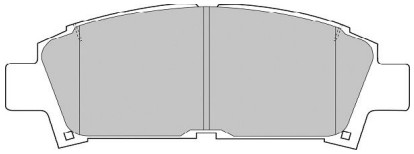

141 x 57 x 15mm
Toyota

PP275

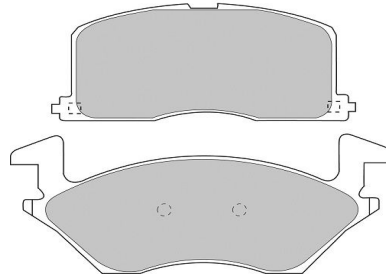

106/133 x 46/55 x 13mm
Toyota

PP276

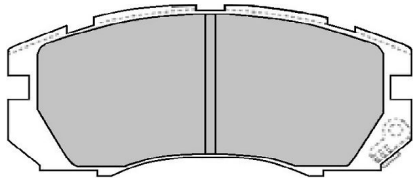

128 x 59 x 17mm
Subaru

PP277

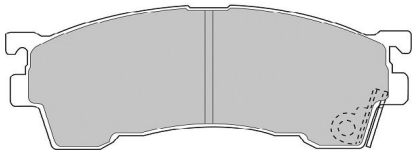

132 x 52 x 15.5mm
Ford, Mazda

PP278

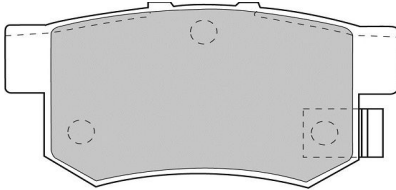

88 x 48 x 14.5mm
Honda, MG, Rover, Suzuki

PP279

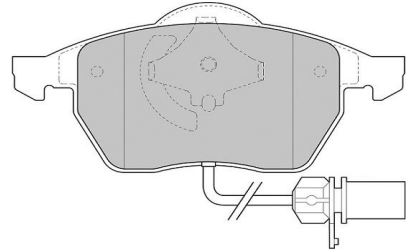

156.4 x 71 x 19.5mm
Audi, Ford, Volkswagen

PP280

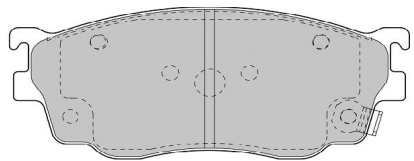

132 x 56 x 15mm
Mazda

PP282

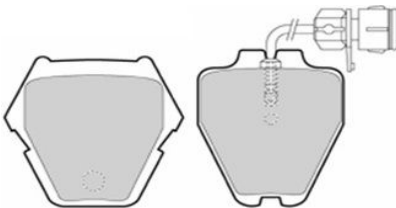

63.5/78 x 76/76.5 x 18mm (NB: 8pad set)
Audi

PP283

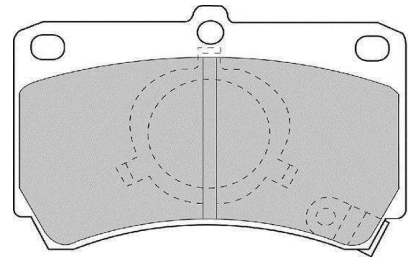

92 x 64 x 15mm
Mazda

PP284

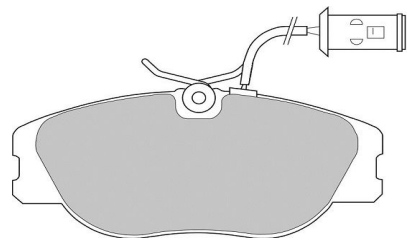

130 x 59 x 19mm
Alfa Romeo

PP285

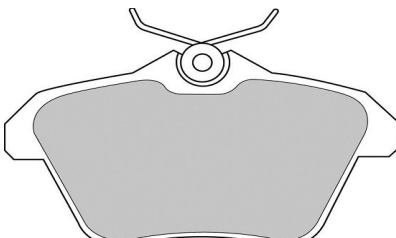

90 x 50 x 16mm
Alfa Romeo, Lancia

PP286

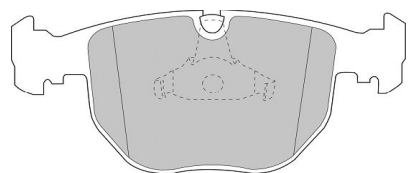

156 x 73 x 19mm
BMW

BRAKE PADS

PP287

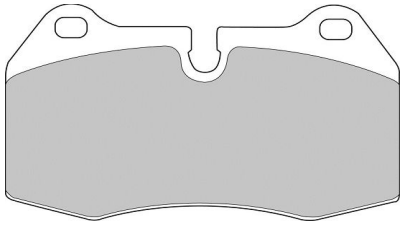

120 x 74 x 18mm
BMW, Nissan

PP289

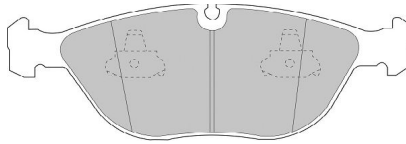

195 x 74 x 20.5mm
Audi, BMW, Mercedes, Volkswagen

PP292

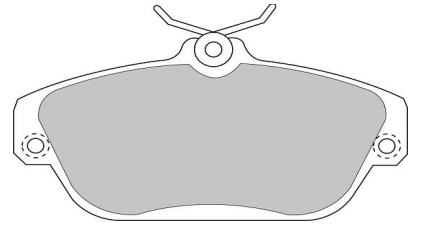

128 x 67 x 17.5mm
Volvo

PP295

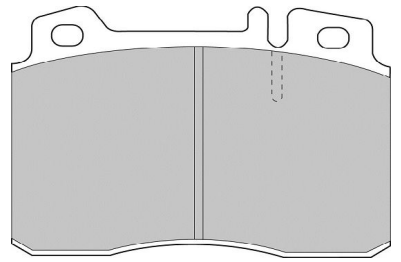

100 x 74 x 16mm
Mercedes

PP297

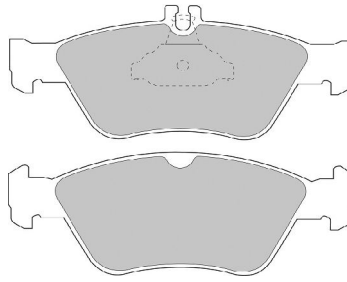

151.5 x 66/60 x 19mm
Mercedes

PP298

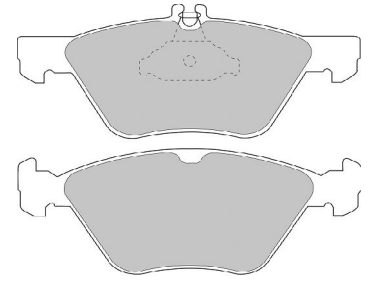

156.5 x 69.5/67 x 19.5mm
Chrysler, Mercedes

PP299

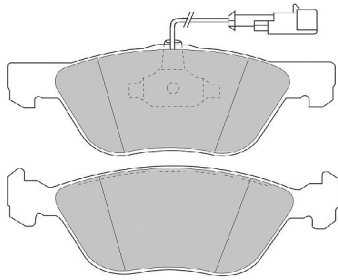

156 x 60/58 x 18mm
Alfa Romeo, Fiat, Lancia

PP300

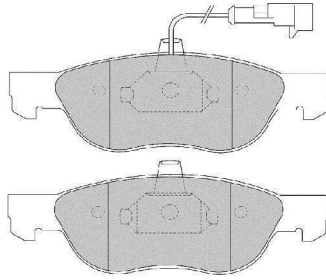

156.5 x 52.5 x 17mm
Alfa Romeo, Fiat, Lancia

PP301

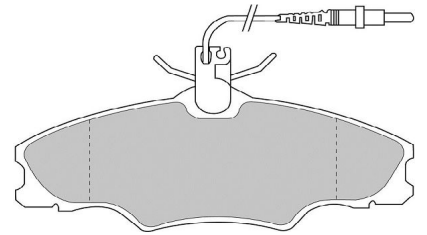

130 x 52 x 18.5mm
Peugeot

PP302

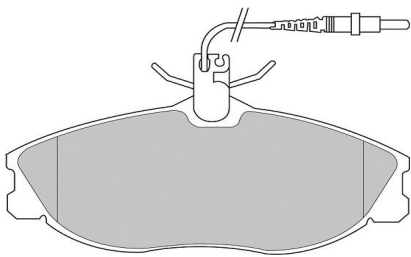

130 x 57 x 18mm
Citroën, Peugeot

PP303

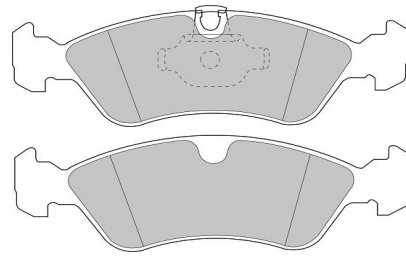

156.5 x 52 x 17.5mm
Vauxhall

PP304

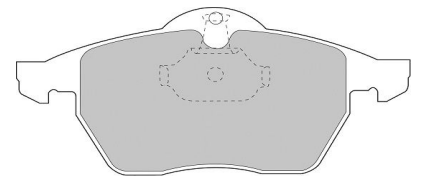

157 x 74 x 19.5mm
Saab, Vauxhall

PP305

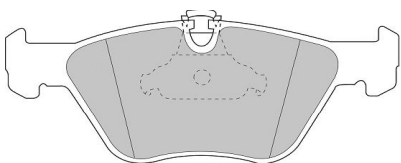

156.5 x 63.5 x 19.5mm
BMW

PP306

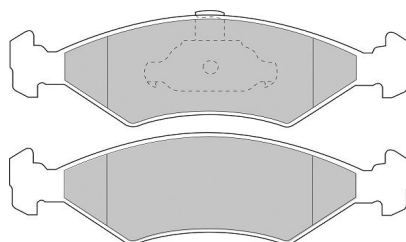

151 x 46 x 18mm
Ford, Mazda

PP307

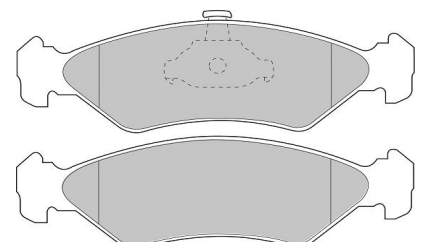

141 x 45 x 18mm
Ford, Mazda

BRAKE PADS

PP308

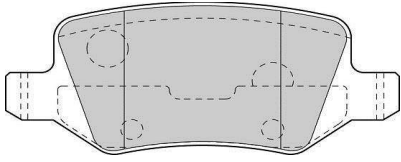

95.5 x 42 x 14.5mm

Mercedes

PP309

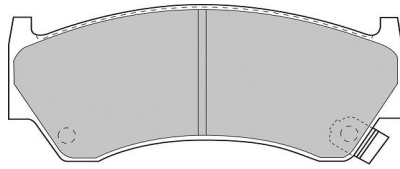

108.5 x 48 x 16mm

Nissan

PP310

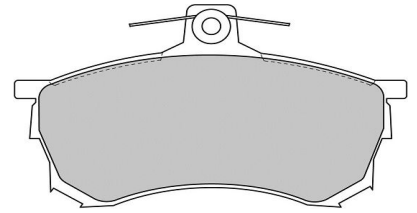

119 x 68.5 x 16mm

Mitsubishi

PP311

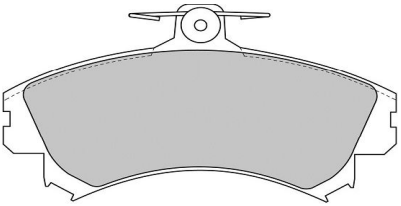

130 x 73 x 15mm

Mitsubishi, Volvo

PP312

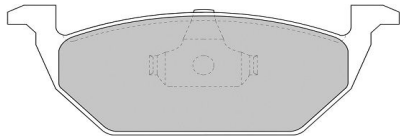

146 x 54.5 x 19.5mm

Audi, Seat, Skoda, Volkswagen

PP313

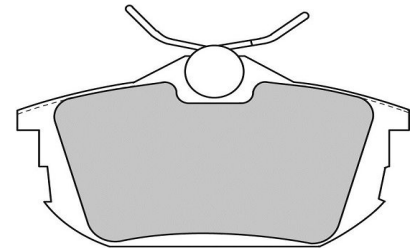

87 x 47 x 15mm

Mitsubishi, Proton, Smart, Volvo

PP314

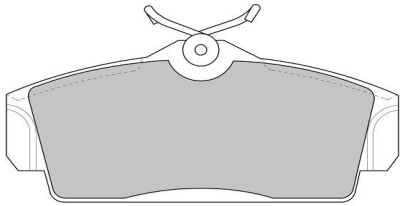

124 x 57 x 16.5mm

Nissan

PP315

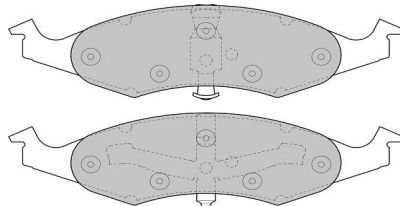

165 x 43 x 16mm

Chrysler

PP316

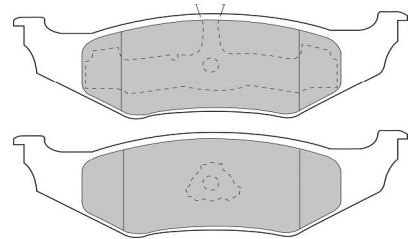

134 x 41 x 17mm

Chrysler

PP317

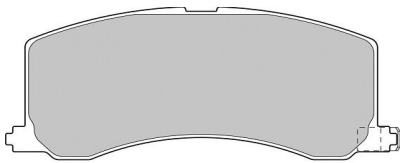

134 x 41 x 17mm

Suzuki

PP318

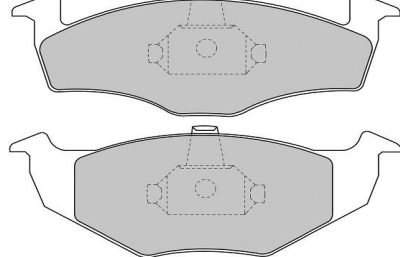

141.5 x 51 x 17mm

Seat, Volkswagen

PP319

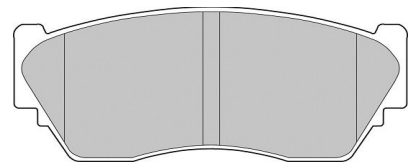

108.5 x 48 x 16mm

Nissan

PP320

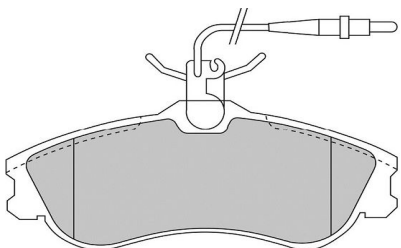

130 x 56 x 19mm

Citroën

PP321

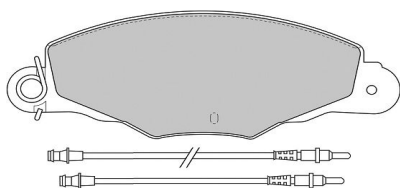

169 x 62 x 17.5mm

Citroën

PP322

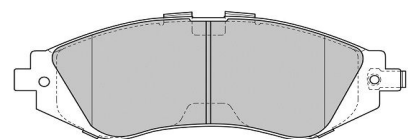

143 x 51 x 18mm

Chevrolet, Daewoo, Daihatsu

BRAKE PADS

PP323

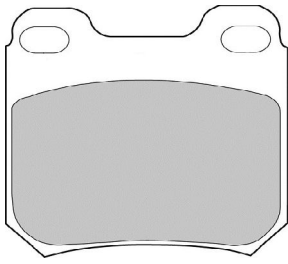

62 x 61 x 15.5mm
Saab, Vauxhall

PP325

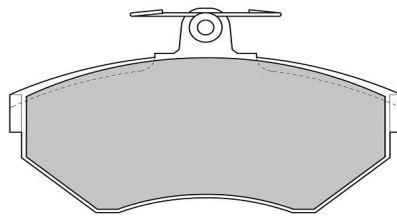

119 x 70 x 19mm
Volkswagen

PP327



131 x 47.5 x 18mm
Citroën

PP328

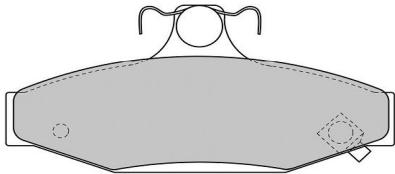

114 x 56 x 14.5mm
Daewoo, Ssangyong

PP329

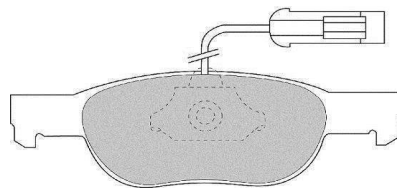

151 x 50 x 17mm
Alfa Romeo, Fiat, Lancia

PP330

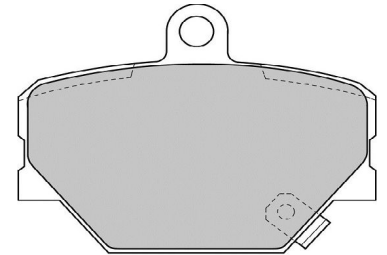

90 x 70 x 15.5mm
BMW

PP333

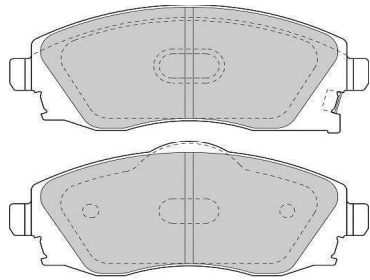

132 x 52 x 17mm
Vauxhall

PP337

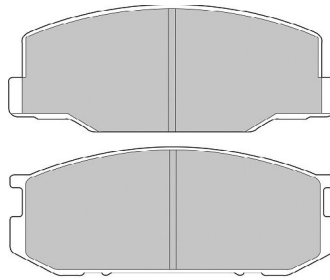

128/127 x 55/57 x 16mm
Lotus, Toyota

PP340

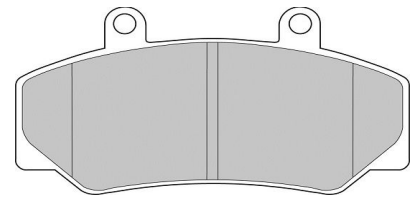

114 x 62 x 16.5mm
Volvo

PP341

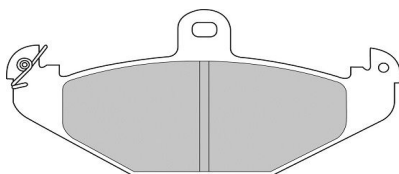

126 x 59 x 15mm
Mercedes

PP342

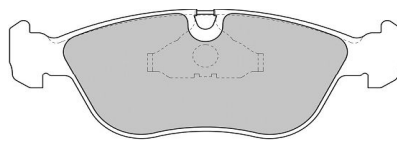

156.5 x 58 x 19.5mm
Volvo

PP343

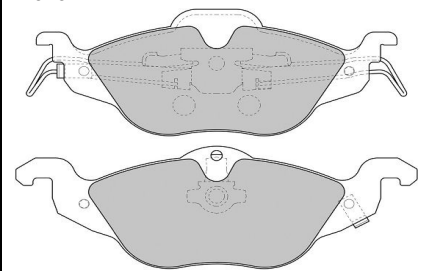

160/178 x 63/62 x 18mm
Vauxhall

PP344

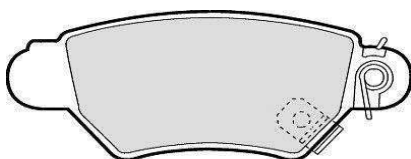

105 x 43 x 16mm
Vauxhall

PP345

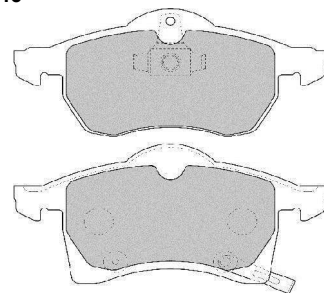

156.5/155 x 79.5/72 x 19.5/20.5mm
Vauxhall

PP346

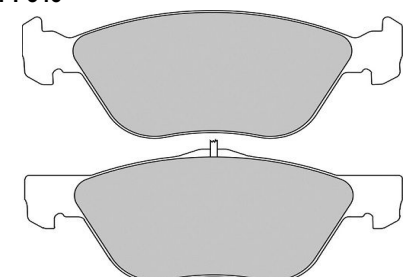

155/156 x 59 x 19mm
Alfa Romeo, Lancia

BRAKE PADS

PP347

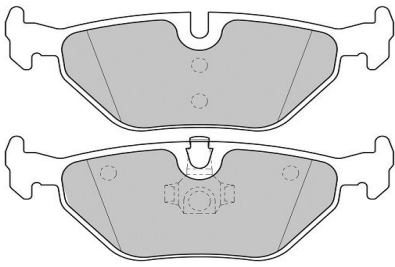

123 x 43.5 x 16.5mm

BMW, Rover Group, Saab

PP348

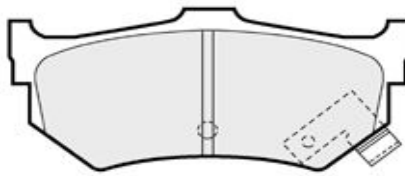

86 x 39 x 13mm

Honda, Suzuki

PP349

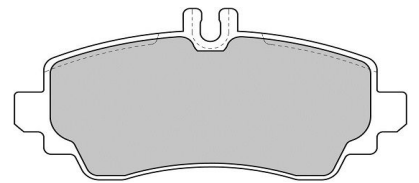

116 x 57 x 17mm

Mercedes

PP351

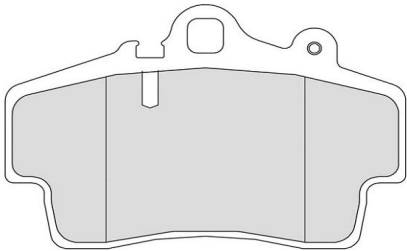

114 x 78 x 16mm

Porsche

PP352

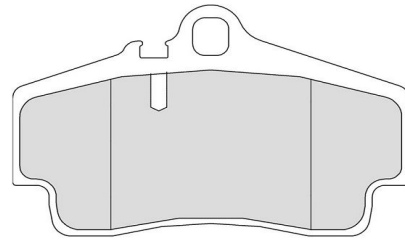

112 x 73 x 16mm

Porsche

PP353

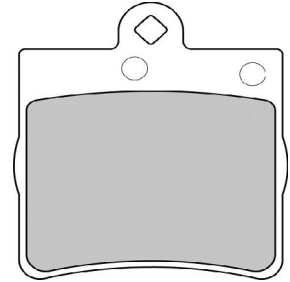

64 x 73 x 15mm

Chrysler, Mercedes

PP354

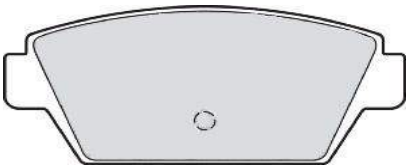

98 x 44 x 14mm

Mitsubishi

PP357

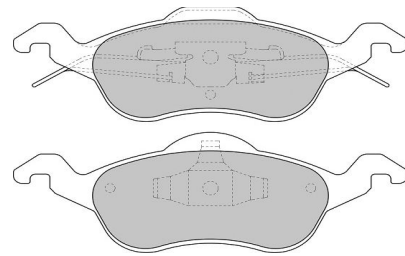

178 x 61 x 19mm

Ford

PP358

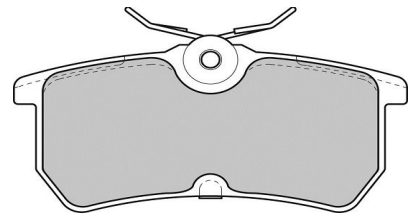

87 x 46 x 15mm

Ford

PP359

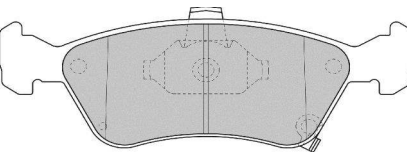

156.5 x 55 x 18mm

Toyota

PP360

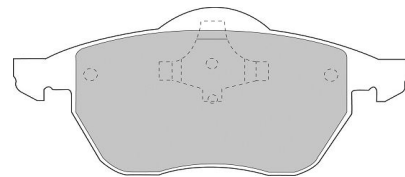

156.5 x 74 x 20.5mm

Audi, Skoda, Volkswagen

PP361

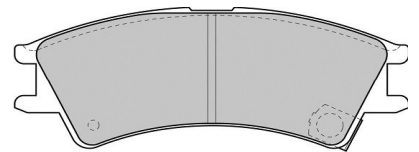

105 x 42 x 16mm

Hyundai

PP362

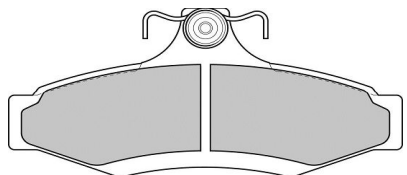

114 x 55 x 14mm

Daewoo

PP363

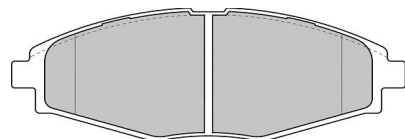

127 x 48 x 17mm

Chevrolet, Daewoo

PP364

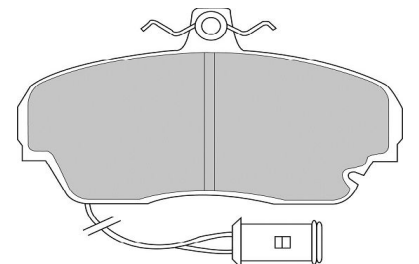

130 x 72 x 17mm

Honda, Rover Group

BRAKE PADS

PP366

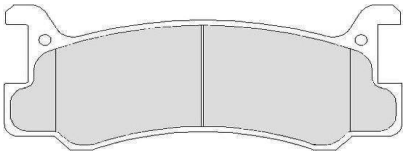

101.5 x 42 x 13mm
Daihatsu, Mazda

PP367

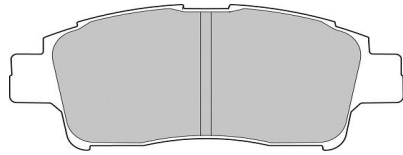

112.5 x 46.5 x 16.5mm
Toyota

PP368

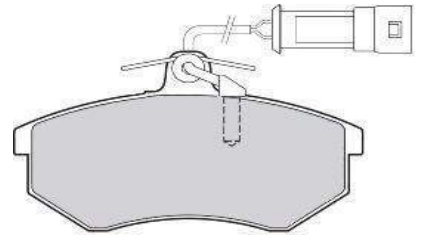

119 x 70 x 16mm
Audi

PP372

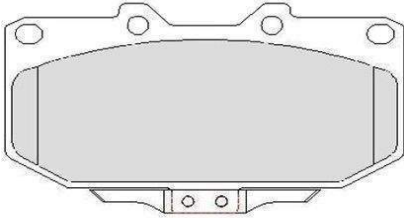

119 x 62/70 x 14mm
Mitsubishi, Nissan, Subaru

PP374

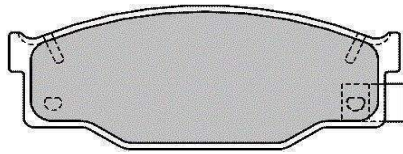

112 x 46 x 13mm
Isuzu

PP376

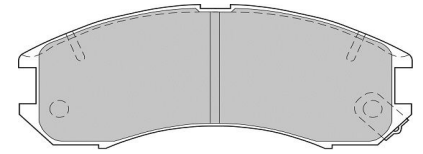

130 x 52 x 15mm
Ford, Mazda

PP379

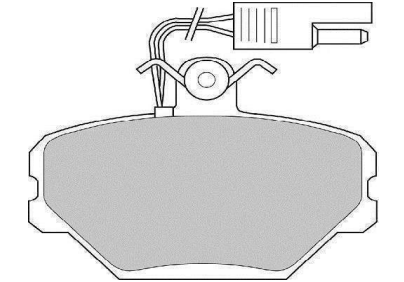

90 x 65 x 17mm
Yugo

PP380



104 x 42 x 13mm
Ford, Mazda

PP381

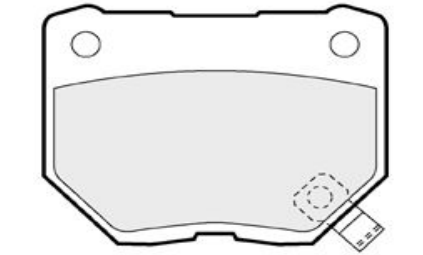

73 x 55 x 15mm
Nissan, Subaru

PP382

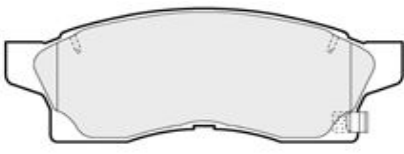

140.5 x 52 x 14mm
Toyota

PP383

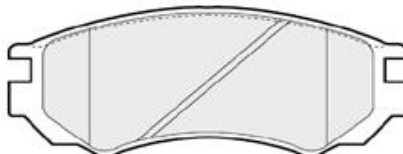

128 x 52 x 15mm
Nissan

PP384

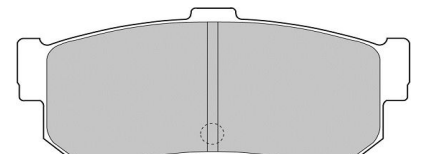

105 x 47 x 16.5mm
Nissan

PP385

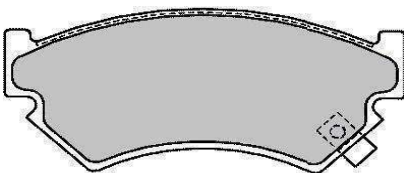

108.5 x 49.5 x 14.5mm
Subaru

PP389

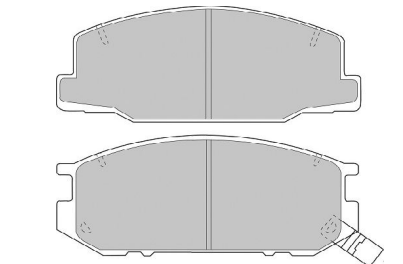

128/127 x 55/57 x 16mm
Toyota

PP392

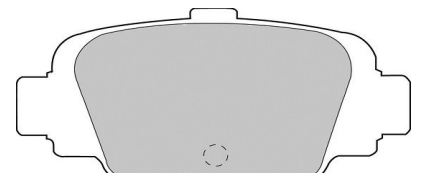

89 x 45 x 15mm
Nissan

BRAKE PADS

PP393

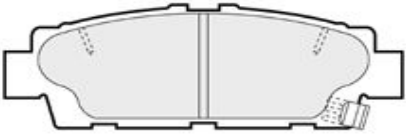

117 x 41 x 16mm
Lexus

PP394

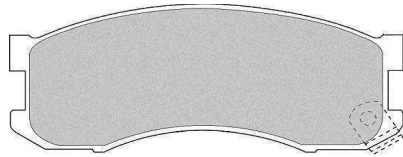

133 x 56 x 15mm
Mazda

PP395

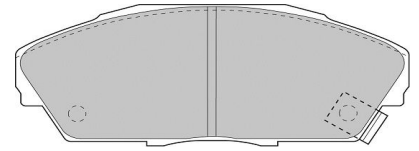

128 x 53 x 18mm
Honda, Rover Group

PP398

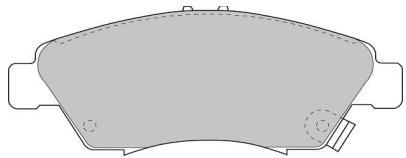

138 x 55 x 16.5mm
Honda

PP399

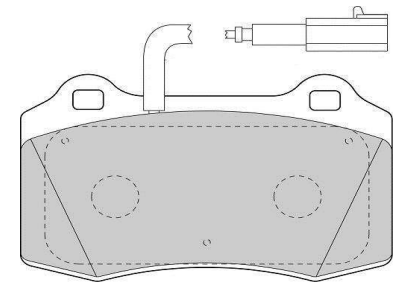

110 x 69 x 18mm
Alfa Romeo, Fiat, Lancia

PP400

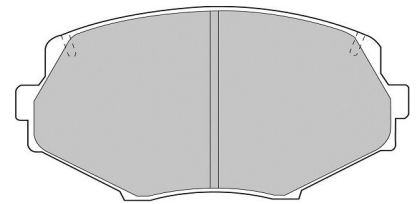

110 x 61 x 13mm
Mazda

PP401

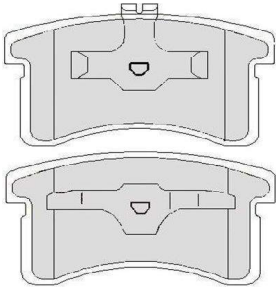

89 x 49 x 14mm
Daihatsu, Perodua

PP402

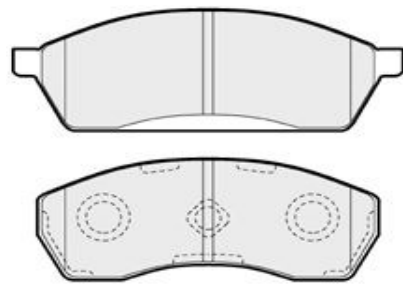

112/98 x 39 x 13.5mm
Subaru

PP403

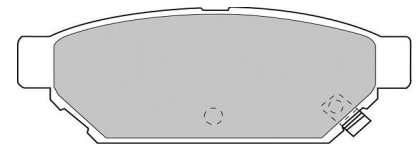

99 x 38 x 14mm
Mitsubishi, Proton

PP404

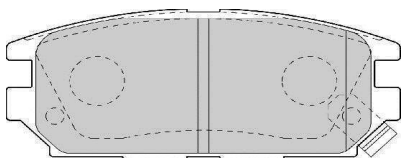

108 x 46 x 15mm
Mitsubishi

PP406

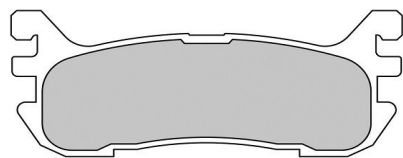

102 x 43 x 12.5mm
Mazda

PP408

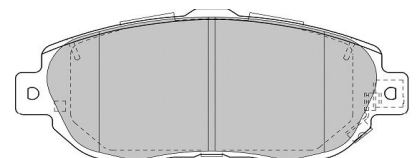

144 x 64 x 18mm
Lexus, Toyota

PP409

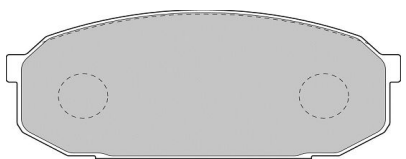

128 x 53 x 16mm
Mazda

PP410

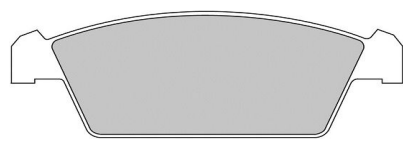

108 x 39 x 14mm
Suzuki

PP412

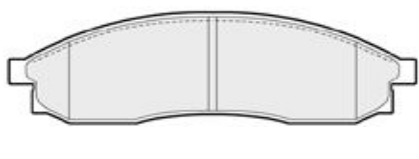

151 x 51 x 17mm
Nissan

BRAKE PADS

PP413

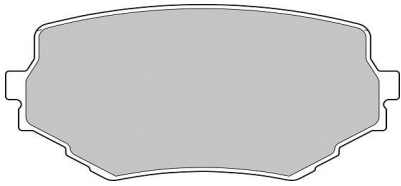

110 x 55 x 14mm
Suzuki

PP414

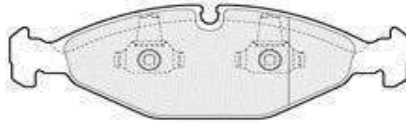

194 x 62 x 18mm
Jaguar

PP417

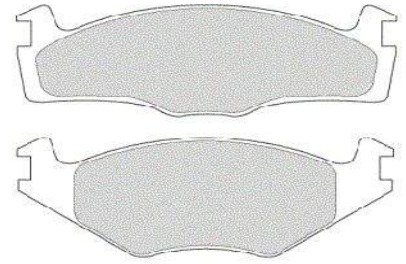

140 x 50 x 17mm
Skoda, Volkswagen

PP418

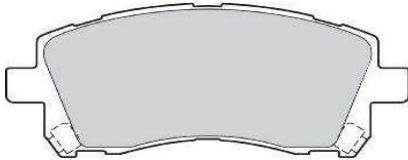

137.5 x 60 x 17mm
Subaru

PP421

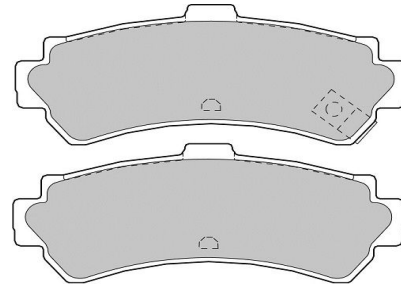

99 x 40 x 15mm
Nissan

PP422

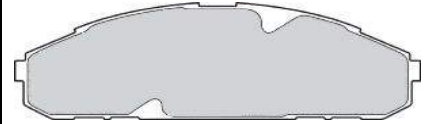

170 x 54 x 18mm
Nissan

PP423

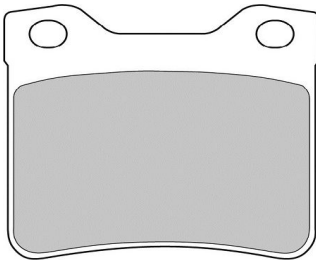

64 x 57 x 16mm
Peugeot

PP424

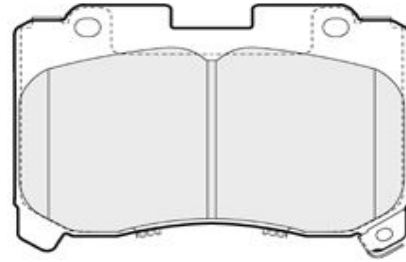

119 x 83 x 17mm
Toyota

PP425

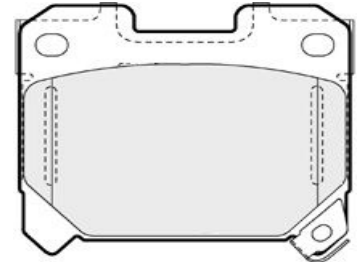

81 x 69 x 16mm
Toyota

PP426

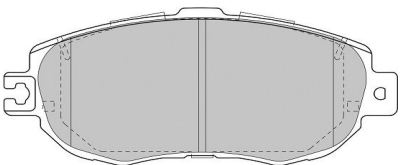

144 x 64 x 17mm
Lexus

PP427



122 x 40 x 16mm
Lexus, Toyota

PP429

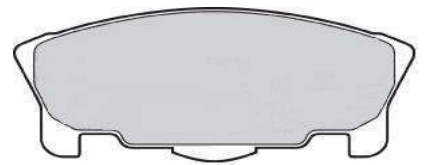

105 x 45 x 14mm
Daihatsu

PP430

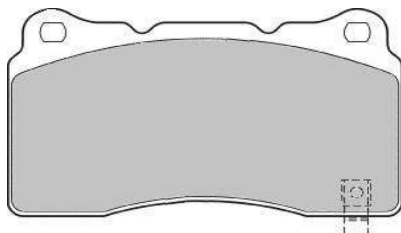

132 x 77 x 16mm
Mitsubishi, Subaru, Volvo

PP432

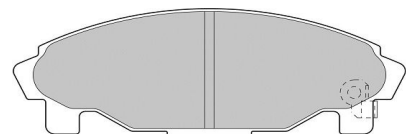

125 x 45 x 15mm
Daihatsu

PP434

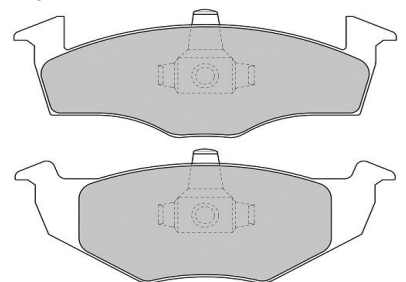

142 x 48/51 x 15mm
Seat, Volkswagen

BRAKE PADS

PP435

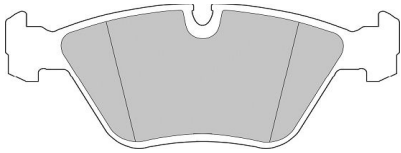

156 x 62 x 18mm
Audi, Jaguar

PP436

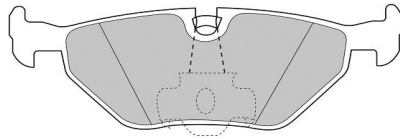

123 x 45 x 17mm
BMW

PP438

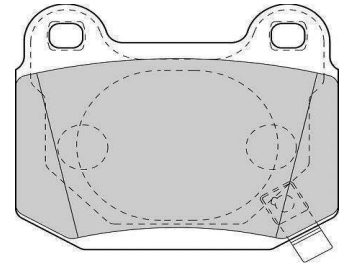

78 x 66 x 14mm
Mitsubishi, Nissan, Subaru, Vauxhall

PP439

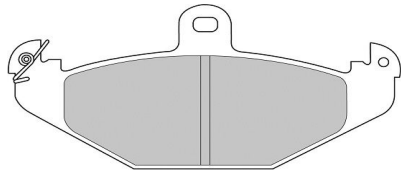

126 x 59 x 14mm
Vauxhall

PP442

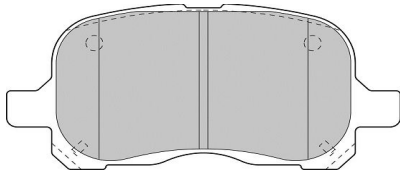

116.5 x 55 x 16.5mm
Toyota

PP443

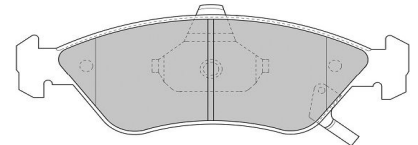

151 x 57.5 x 18mm
Kia

PP444

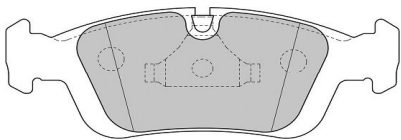

150 x 57.5 x 18mm
BMW

PP445

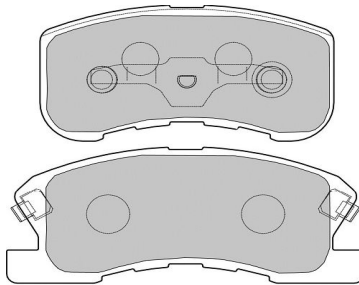

95/115.5 x 49.5 x 15.5mm
Kia, Perodua

PP446

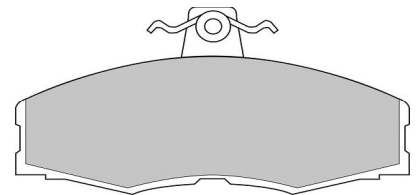

115 x 60 x 15mm
Ford, Skoda

PP447

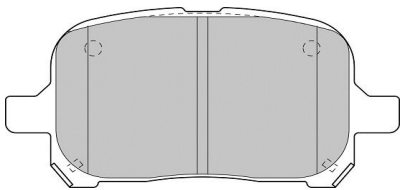

117 x 60 x 17mm
Toyota

PP449

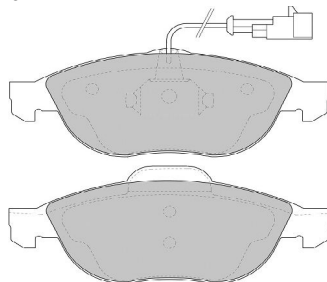

155/156 x 59/63 x 19mm
Alfa Romeo, Lancia

PP450

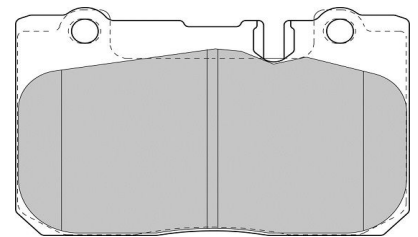

116 x 75 x 17mm
Lexus

PP451

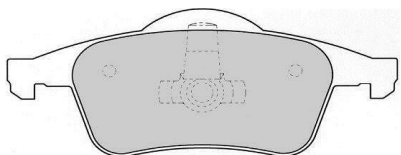

123 x 54 x 16.5mm
Volvo

PP452

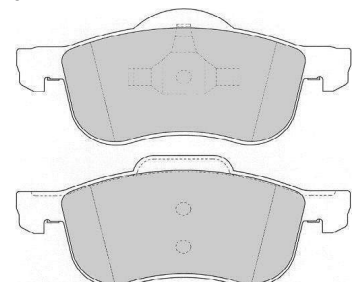

156.5 x 73 x 19mm
Volvo

PP453

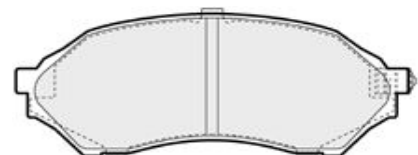

123 x 52 x 15mm
Mazda, Mercedes

BRAKE PADS

PP454

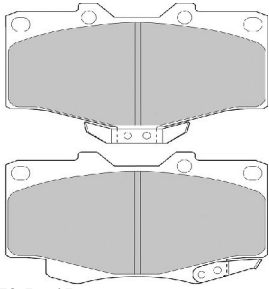

119 x 68/73.5 x 15mm
Toyota

PP455

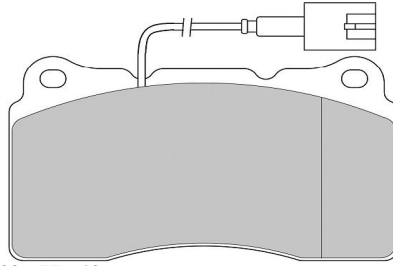

132 x 77 x 16mm
Alfa Romeo

PP456

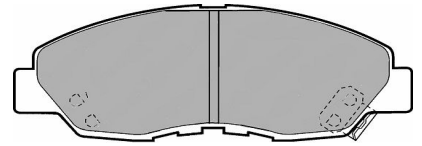

138 x 54 x 18mm
Honda

PP457

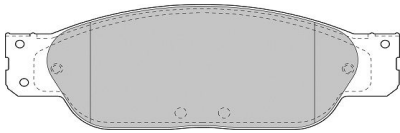

163 x 58 x 17.5mm
Jaguar

PP458

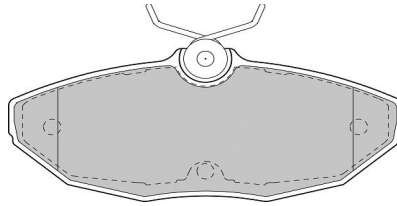

114 x 50 x 18mm
Jaguar

PP459

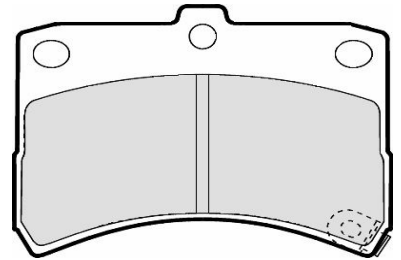

80 x 58 x 14mm
Daihatsu, Perodua

PP460

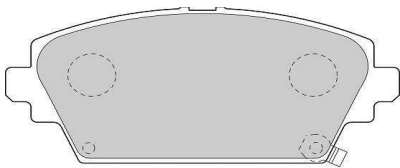

131.5 x 58.5 x 17mm
Honda, MG

PP461

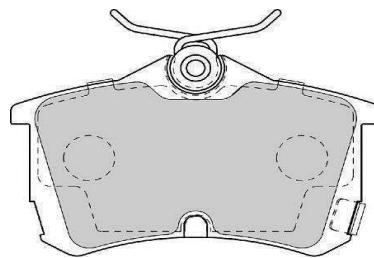

87 x 53 x 15mm
Honda

PP462

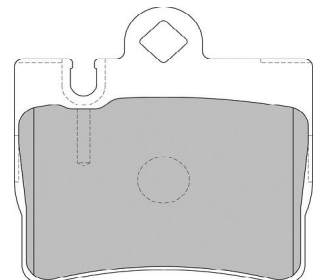

71 x 69 x 16mm
Mercedes

PP463

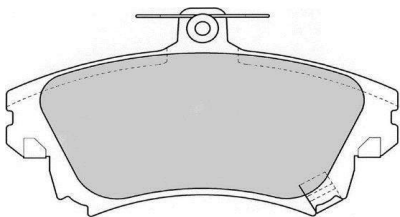

130 x 78 x 17mm
Mitsubishi, Smart, Volvo

PP464

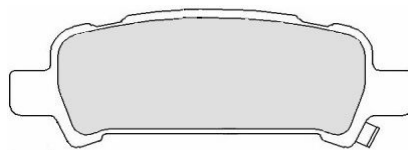

108.5 x 41.5 x 14.5mm
Subaru

PP465

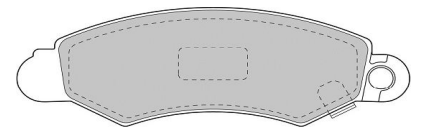

131 x 44 x 15mm
Suzuki

PP466

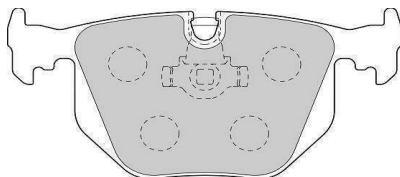

123 x 59 x 17mm
BMW, Land Rover

PP467

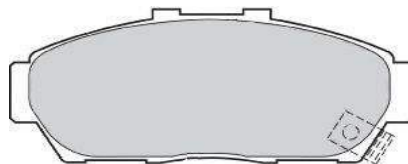

148.5 x 57.5 x 17mm
Honda

PP468

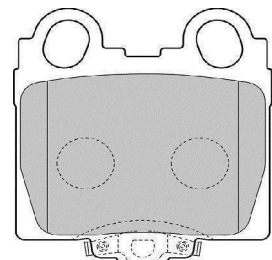

57 x 64 x 15.5mm
Lexus

BRAKE PADS

PP469

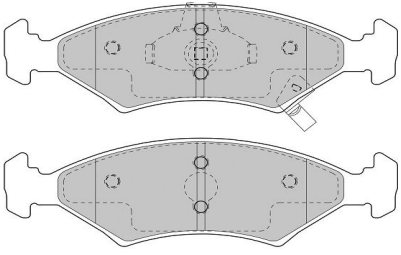

151 x 46 x 17mm

Kia

PP470

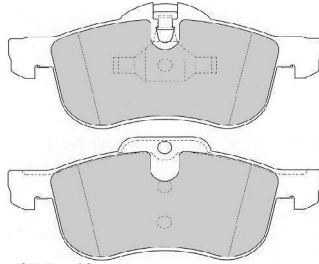

156.5 x 67.5 x 19mm

MG, Rover

PP471

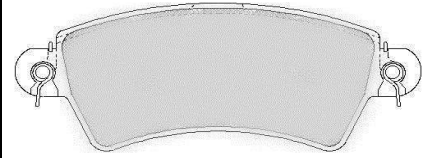

131 x 51 x 18mm

Citroën, Peugeot

PP472

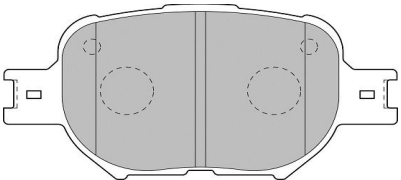

117.5 x 58 x 17.5mm

Toyota

PP473

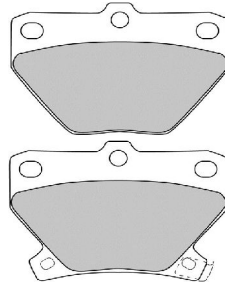

78.5 x 52/54 x 14mm

Toyota

PP474

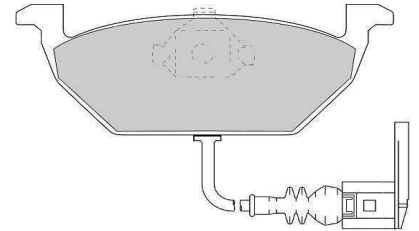

146 x 55 x 20mm

Audi, Seat, Skoda, Volkswagen

PP475

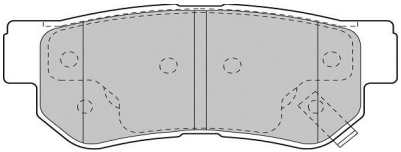

98.5 x 41 x 15mm

Hyundai, Kia

PP476

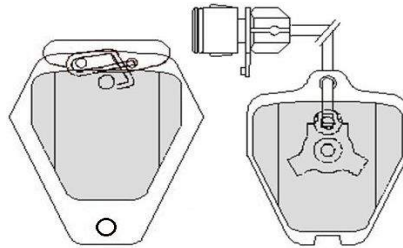

76/63.5 x 85.5/77.5 x 18mm (NB: 8pad set)

Audi

PP477

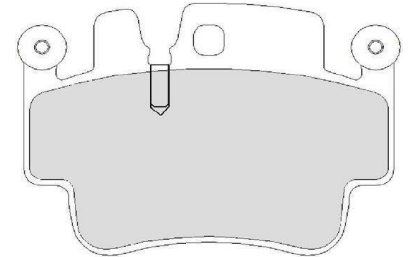

121 x 91.6 x 16.9mm

Porsche

PP478



142 x 55 x 18mm

Nissan

PP479

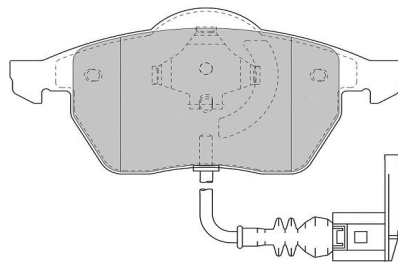

156 x 74 x 20mm

Audi, Seat, Skoda, Volkswagen

PP480

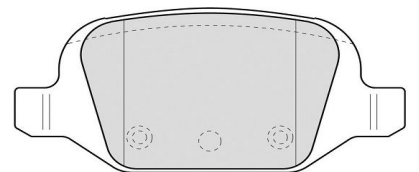

95.5 x 44 x 13.5mm

Fiat

PP481

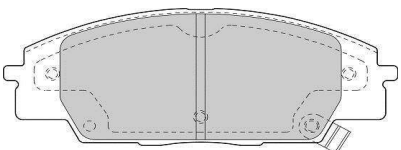

135 x 52 x 16.5mm

Honda

PP483

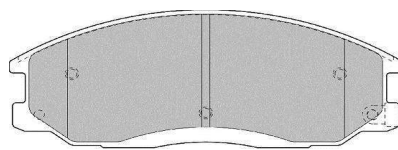

149 x 58 x 17mm

Hyundai, Ssangyong

PP484

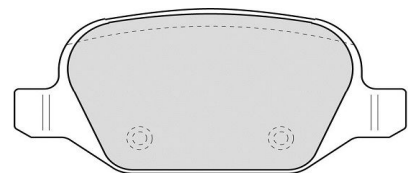

95.5 x 44 x 16.5mm

Alfa Romeo, Lancia

BRAKE PADS

PP486

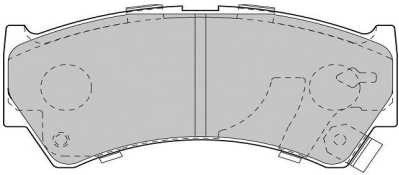

108.5 x 49.5 x 15mm

Suzuki

PP487

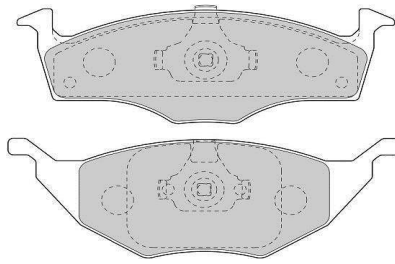

141/147 x 48/50 x 14mm

Volkswagen

PP488

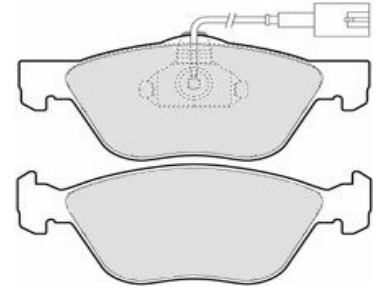

155/156.5 x 61.5/59 x 18.5mm

Alfa Romeo

PP489

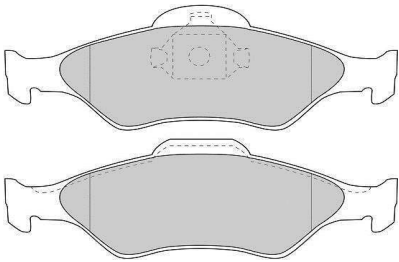

151 x 54.5 x 18.5mm

Ford

PP490

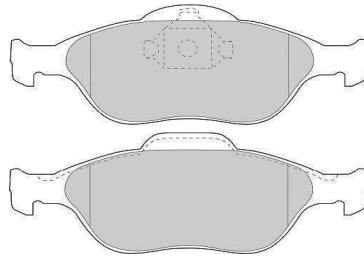

151 x 61.5 x 18.5mm

Ford, Mazda

PP491

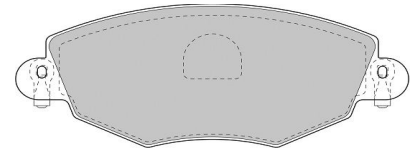

149 x 61 x 18mm

Ford, Jaguar

PP492

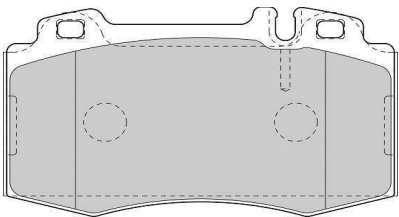

120 x 71.5 x 17.5mm

Mercedes

PP494

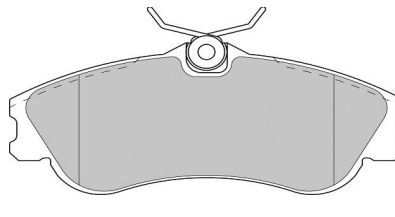

130 x 56 x 19mm

Citroën

PP495

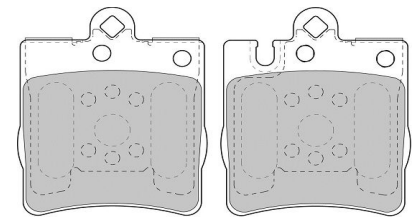

64 x 78 x 15mm

Mercedes

PP496

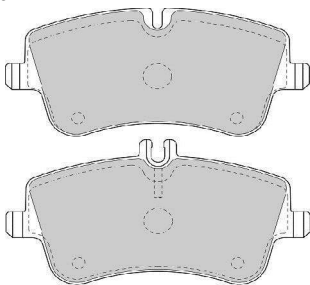

131 x 62/70 x 19.5mm

Mercedes

PP497

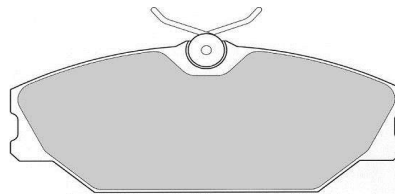

129 x 55 x 18.5mm

Renault

PP498

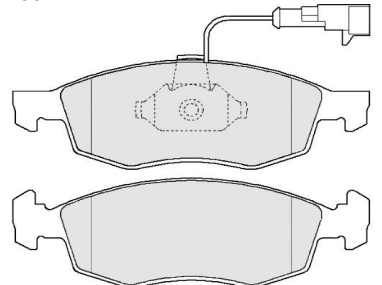

151 x 53 x 18mm

Fiat

PP499

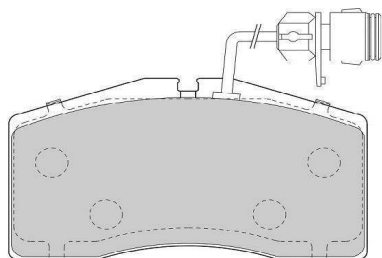

132 x 75 x 18mm

Audi

PP501

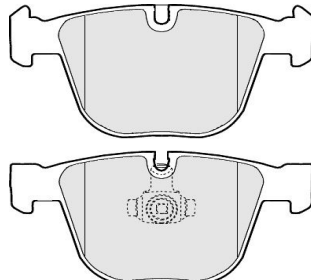

140 x 67.5 x 17.5mm

BMW

PP502

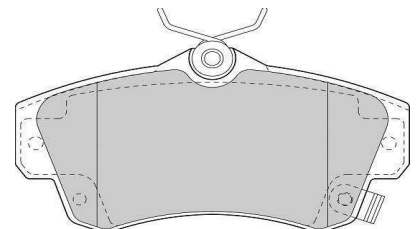

124 x 65 x 20mm

Chrysler

BRAKE PADS

PP503

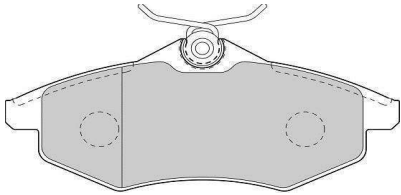

123 x 53 x 19.5mm

Citroën

PP504

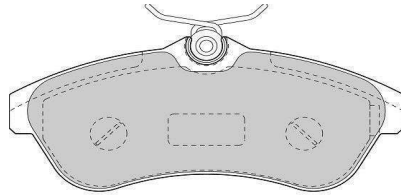

129 x 56 x 19mm

Citroën

PP506

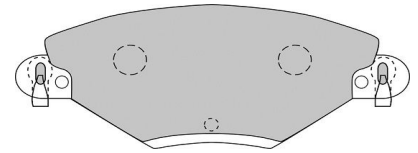

149 x 59 x 18mm

Citroën

PP507

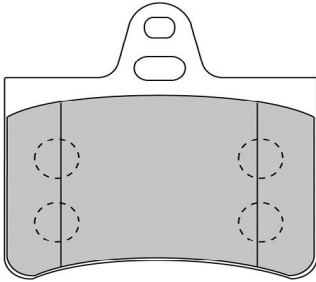

73 x 70.5 x 15mm

Citroën

PP509

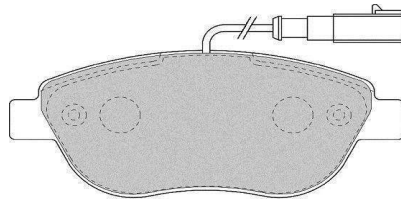

137 x 57.5 x 18.5mm

Fiat

PP510

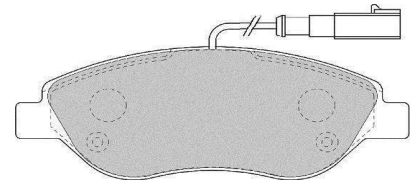

151 x 57.5 x 18.5mm

Fiat

PP511

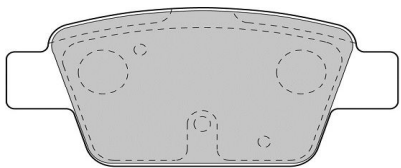

95.5 x 43 x 16mm

Alfa Romeo, Fiat

PP512

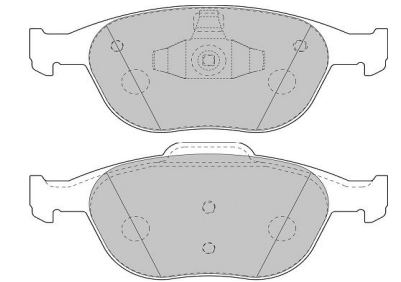

156 x 62/67 x 17.5mm

Ford

PP513

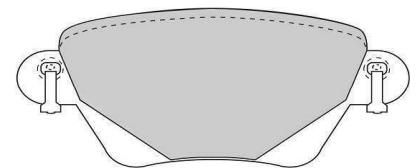

116 x 50 x 17mm

Ford, Jaguar

PP515

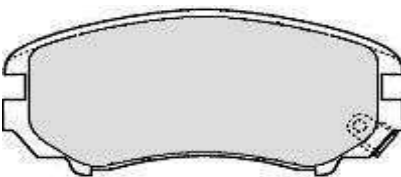

131.5 x 59 x 17.5mm

Hyundai, Kia

PP516

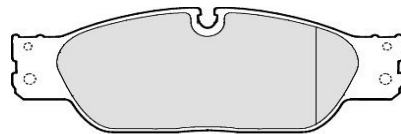

165 x 58 x 17.5mm

Jaguar

PP517

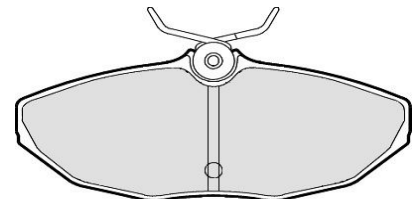

113 x 49 x 17.5mm

Jaguar

PP518



138 x 62 x 17mm

Mazda

PP519



105 x 43 x 15mm

Mazda

PP520

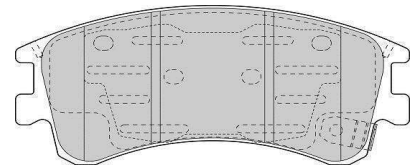

132 x 60 x 18mm

Mazda

BRAKE PADS

PP522

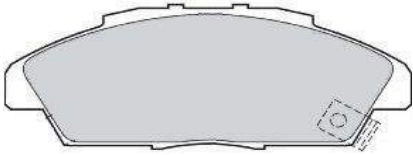

140 x 55 x 18mm
Honda

PP523

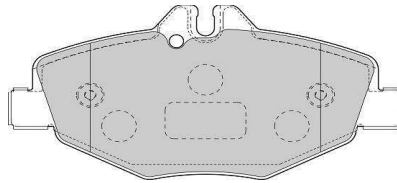

137 x 68 x 21mm
Mercedes

PP524

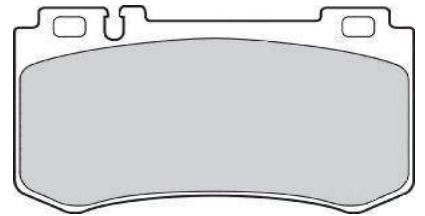

111.5 x 64 x 16mm
Mercedes

PP525

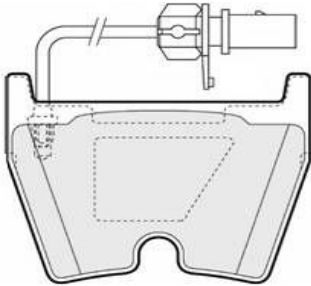

95.5 x 74.5 x 17mm (NB: 8pad set)
Audi, Mercedes, Volkswagen

PP526

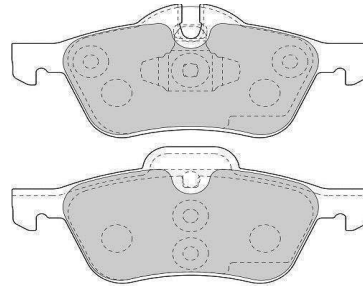

140 x 60 x 18mm
Mini

PP527

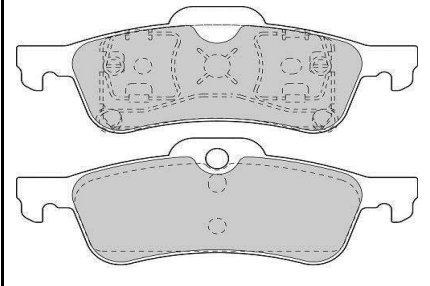

123 x 44 x 17mm
Mini

PP528

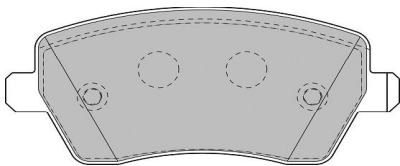

116.5 x 52 x 17mm
Nissan, Renault

PP529

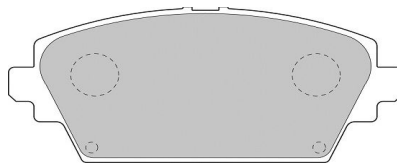

132 x 59 x 18mm
Nissan

PP530

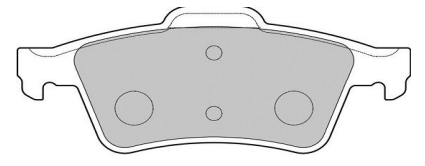

123 x 52 x 16.5mm
Ford, Mazda, Nissan, Renault, Saab, Vauxhall

PP532

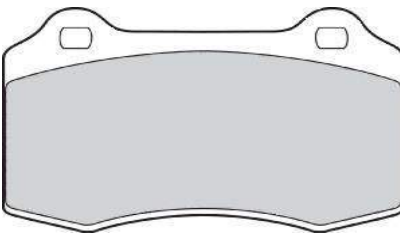

110 x 69 x 15mm
Citroën, Ford, Seat, Volvo

PP533

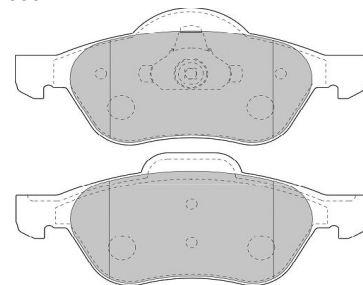

155/156 x 69/67 x 18.5mm
Renault

PP534

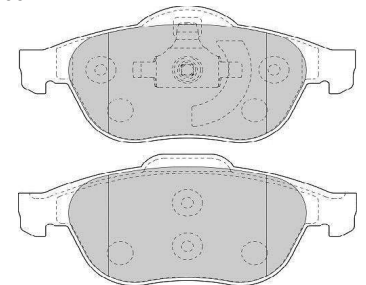

156 x 69/67 x 18.5mm
Renault

PP535

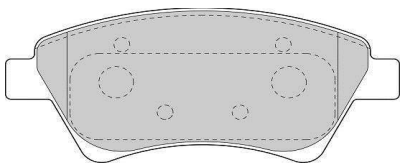

137 x 59.5 x 18.5mm
Renault

PP536

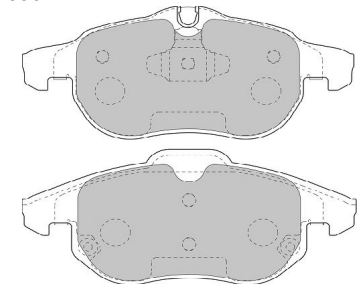

156 x 70.5 x 19.5mm
Cadillac, Fiat, Saab, Vauxhall

PP537

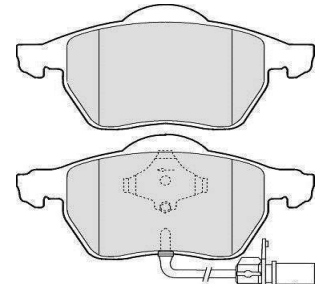

156 x 74 x 20.5mm
Audi, Seat, Skoda, Volkswagen

BRAKE PADS

PP538

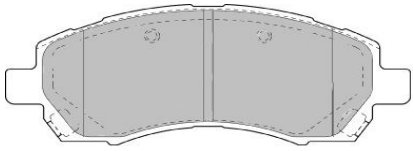

137.5 x 54 x 17.5mm
Subaru

PP539

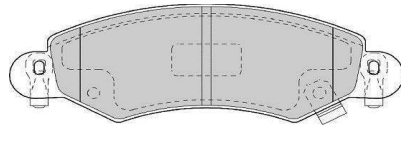

131 x 45 x 16mm
Vauxhall

PP540

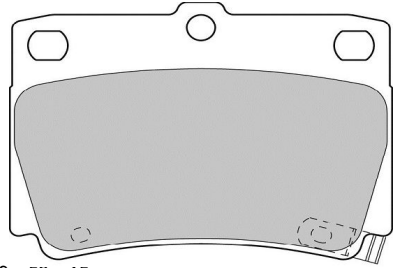

79 x 59 x 15mm
Mitsubishi

PP542

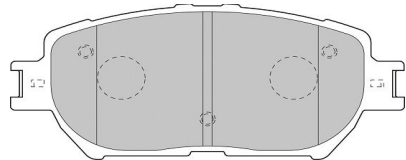

131 x 58 x 17mm
Toyota

PP544

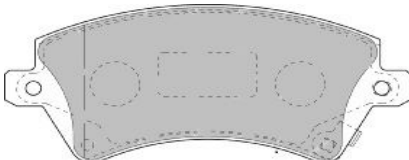

131.5 x 57.5 x 17.5mm
Toyota

PP545

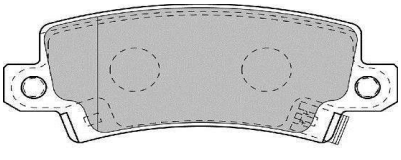

95.5 x 38 x 16mm
Toyota

PP546



131 x 52 x 18mm
Peugeot

PP547

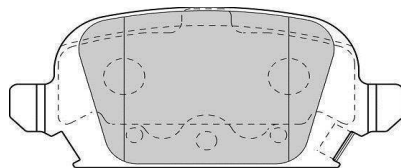

95.5 x 44 x 14mm
Vauxhall

PP548

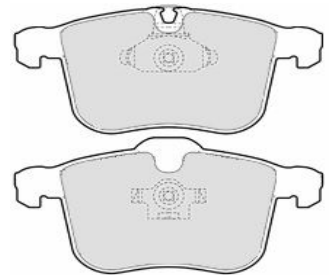

155/156 x 73/77.5 x 20mm
Cadillac, Saab, Vauxhall

PP550

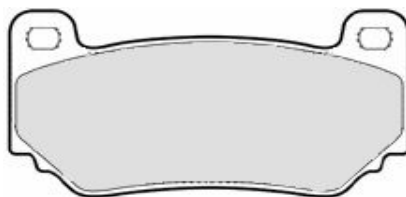

113.5 x 59 x 16.5mm
MG, Mini

PP551

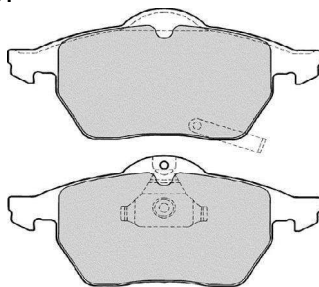

156/155 x 74 x 19.5mm
Vauxhall

PP552



137 x 51.5 x 19mm
Citroën, Peugeot

PP553

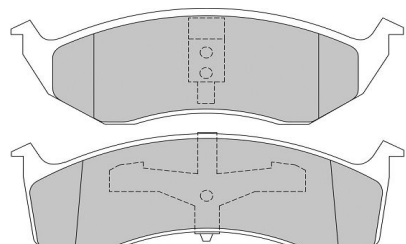

164 x 51 x 15mm
Chrysler

PP554

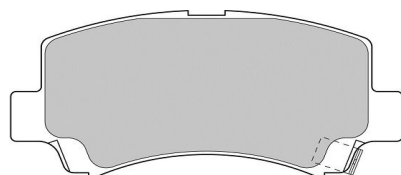

106 x 50 x 15mm
Suzuki

PP555

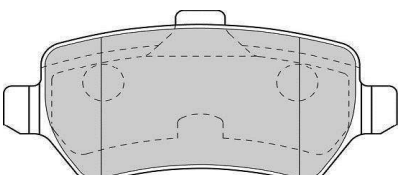

95.5 x 43 x 15mm
Vauxhall

BRAKE PADS

PP556

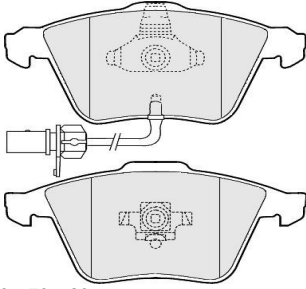

155/156 x 73 x 20mm

Audi

PP557

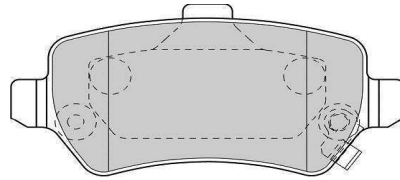

95.5 x 43 x 15mm

Kia, Vauxhall

PP558

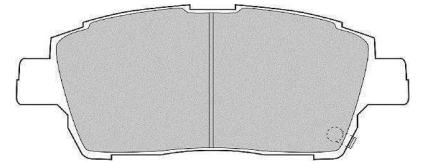

116 x 51 x 17mm

Toyota

PP559

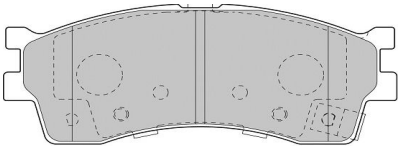

129 x 52 x 16mm

Kia

PP560

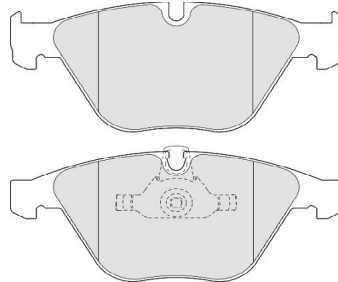

155 x 68.5/66.5 x 20.5mm

BMW

PP561

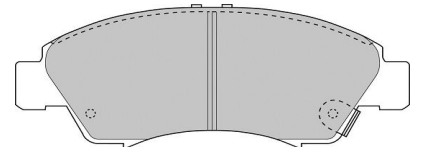

131 x 53 x 16mm

Honda

PP562

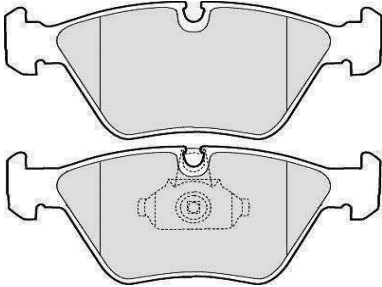

155/156 x 63.5 x 20mm

BMW, MG

PP564

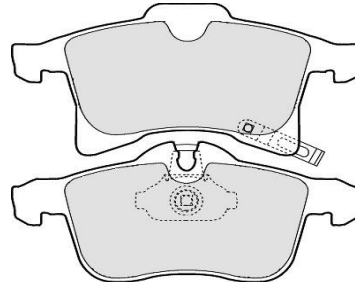

155.5/156.5 x 71/76 x 20.5mm

Vauxhall

PP565

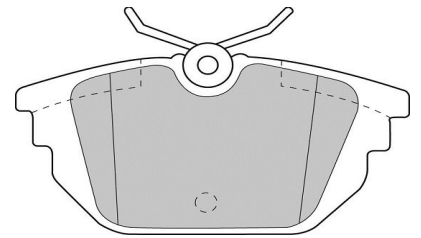

87 x 44.5 x 14.5mm

Alfa, Fiat, Lancia

PP570

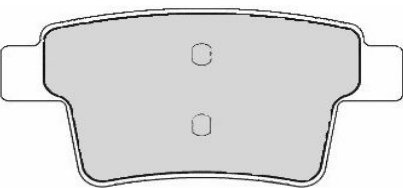

102 x 50.5 x 16.5mm

Ford, Jaguar

PP571

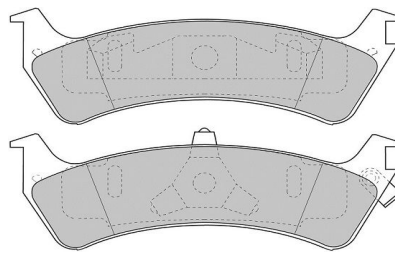

140 x 45 x 15mm

Ford

PP572

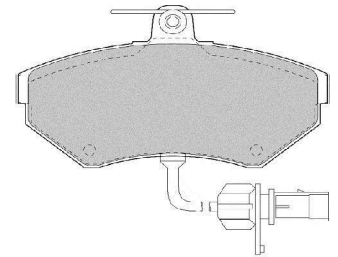

119 x 70 x 19mm

Audi, Seat

PP573

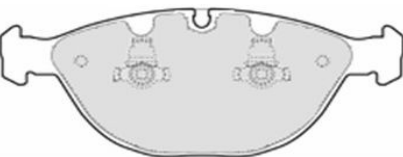

193 x 79 x 20mm

BMW

PP574

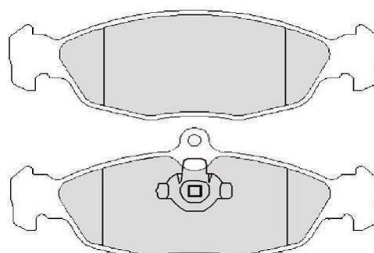

140 x 48/58 x 16.5mm

Jaguar

PP575

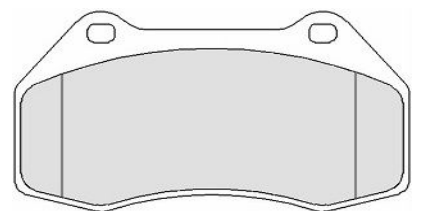

125 x 70 x 15.5mm

Renault

BRAKE PADS

PP576

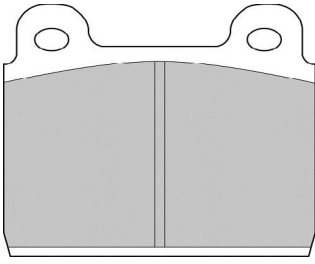

77 x 70 x 18.5mm

Volkswagen

PP577

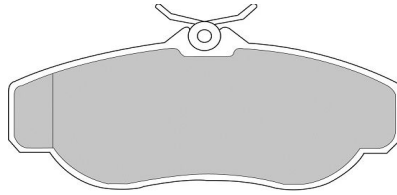

145 x 66 x 18.5mm

Land Rover

PP578

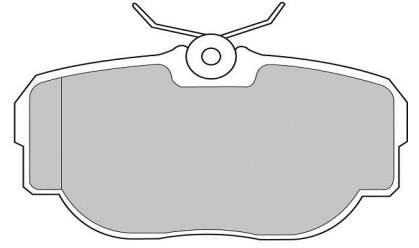

95 x 52 x 15.5mm

Land Rover

PP579

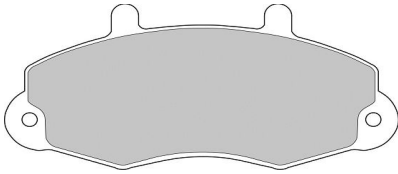

139 x 64 x 19mm

Ford

PP580

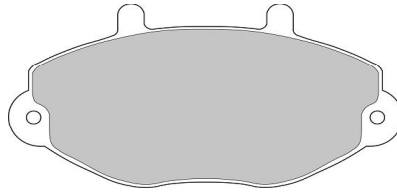

139 x 72 x 19mm

Ford

PP581

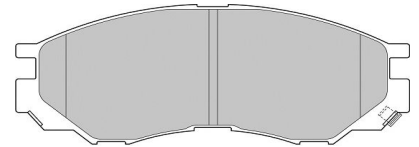

138 x 55 x 17mm

Mitsubishi

PP582

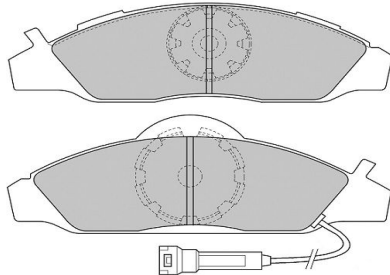

169 x 50/59 x 16mm

Daewoo, Ssangyong

PP583

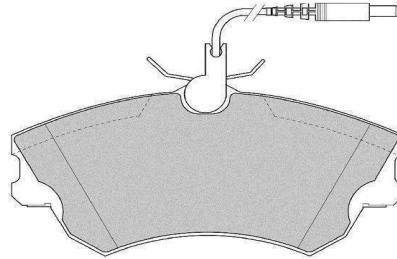

130 x 63 x 18mm

Renault

PP584

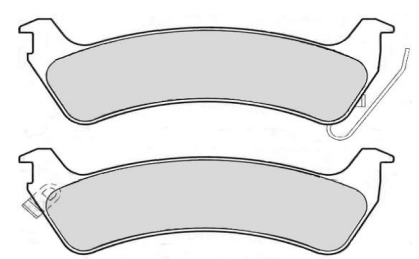

143 x 45 x 15mm

Jeep

PP585

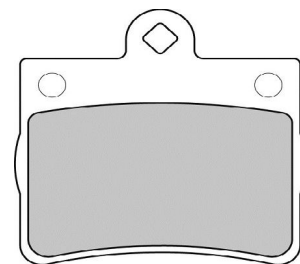

64 x 63 x 15mm

Mercedes

PP586

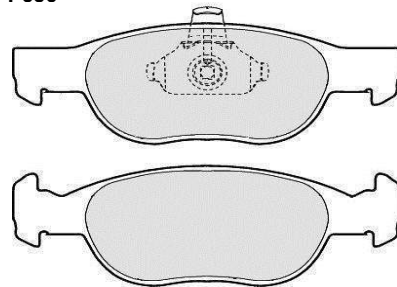

152 x 53 x 17mm

Fiat

PP587

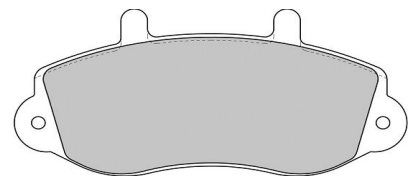

139 x 67 x 18mm

Vauxhall

PP588

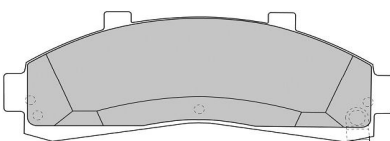

154 x 55 x 17mm

Ford

PP589

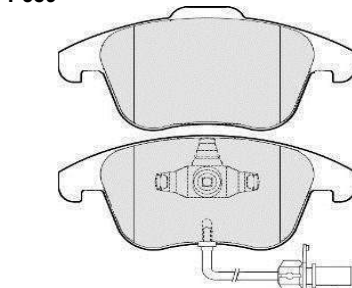

155 x 72/66.5 x 20.5mm

Audi

PP590

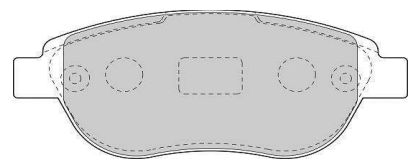

137 x 57.5 x 19.5mm

Citroen, Peugeot

BRAKE PADS

PP591

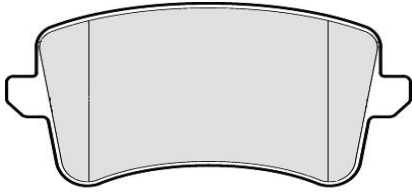

116.5 x 58.5 x 17.5mm

Audi

PP592

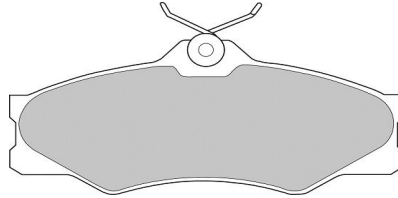

130 x 56 x 19.5mm

Volkswagen

PP593

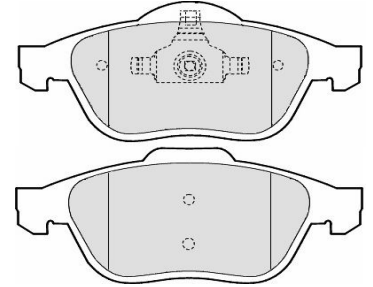

155/156 x 71/68 x 18mm

Renault

PP595

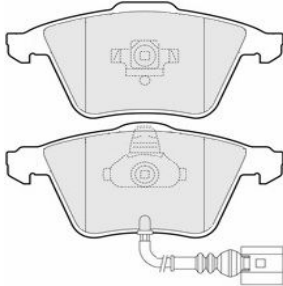

155/156 x 73 x 20mm

Audi, Seat, Skoda, Volkswagen

PP596

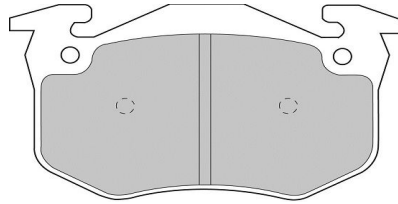

105 x 56 x 11mm

Renault

PP597

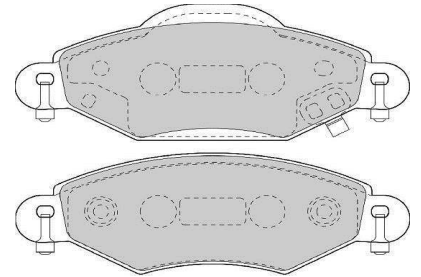

130 x 51/45 x 16mm

Toyota

PP598

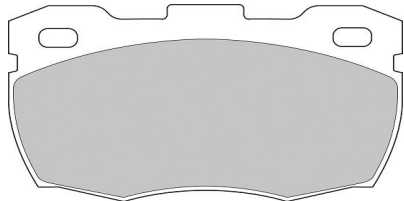

127 x 68 x 18mm

Land Rover

PP599

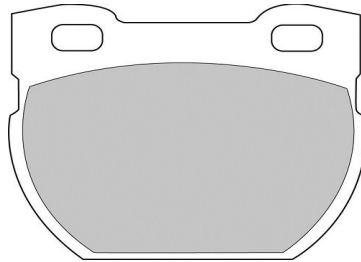

88 x 69 x 14mm

Land Rover

PP600

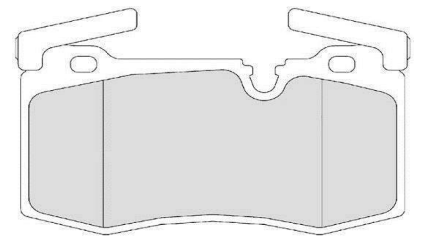

121 x 75.5 x 15mm

Mini

PP601

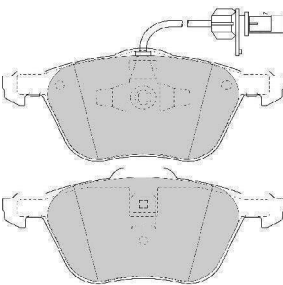

161.5 x 73/74.5 x 20mm

Ford, Seat, Volkswagen

PP602

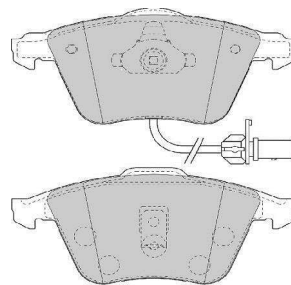

155 x 73 x 20mm

Audi

PP604



131 x 48 x 18.5mm

Peugeot

PP605

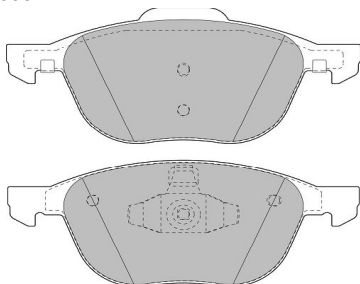

156.5/155 x 67/62.5 x 18.5mm

Ford, Mazda, Volvo

PP607

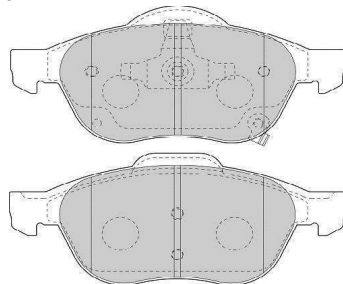

156 x 67.5/71 x 18mm

Toyota

PP608

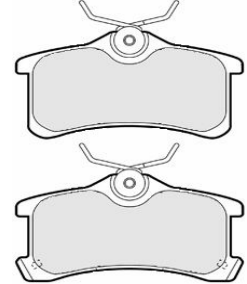

87 x 46 x 16mm

Toyota

BRAKE PADS

PP609

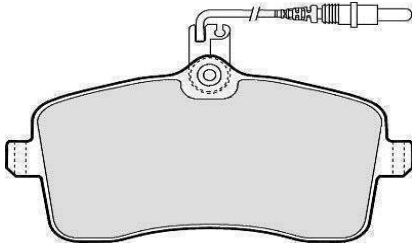

131 x 67 x 19mm
Peugeot

PP610

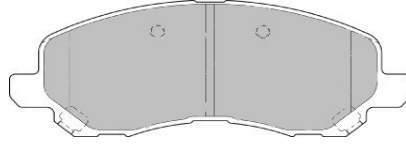

145 x 58 x 15.5mm
Chrysler, Dodge, Jeep, Mitsubishi

PP611

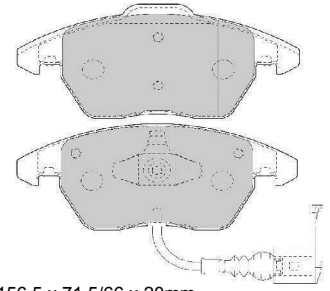

155/156.5 x 71.5/66 x 20mm
Audi, Seat, Skoda, Volkswagen

PP612

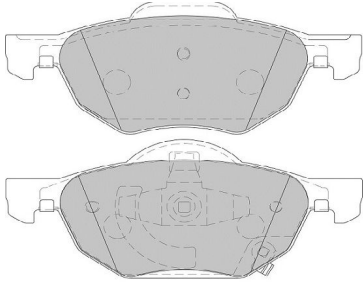

155.5 x 64.5/68 x 17mm
Honda

PP614

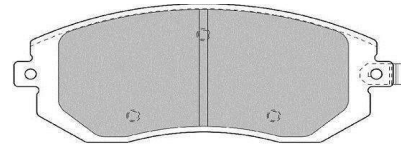

137 x 57 x 17.5mm
Subaru, Toyota

PP615

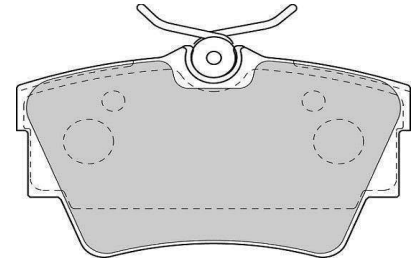

95 x 57 x 17mm
Nissan, Vauxhall

PP616

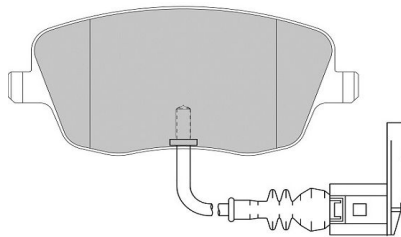

131.5 x 64 x 18.5mm
Seat, Skoda, Volkswagen

PP617

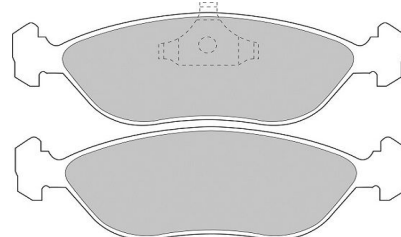

151.5 x 50.5 x 17mm
Volvo

PP619

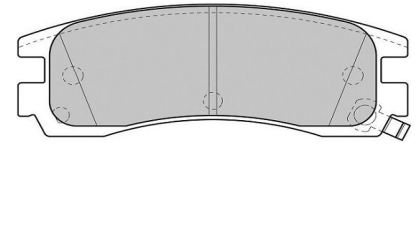

108 x 41 x 15mm
Vauxhall

PP620

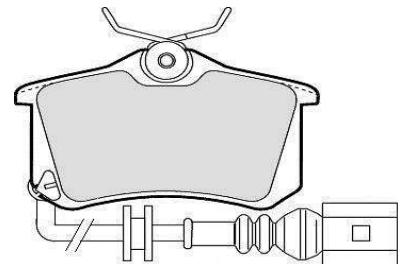

87 x 53 x 17mm
Audi, Seat, Skoda, Volkswagen

PP621

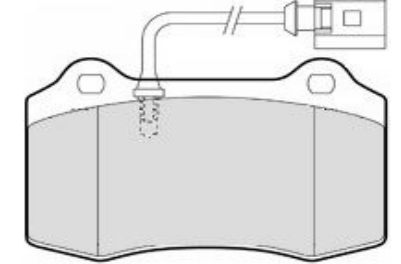

110 x 69 x 15mm
Jaguar, Seat

PP623

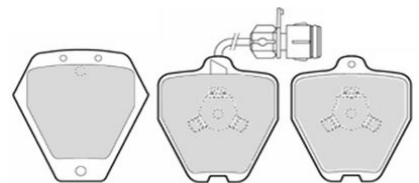

76/63.5 x 85.5/77.5 x 18.5mm (NB: 8pad set)
Audi

PP624

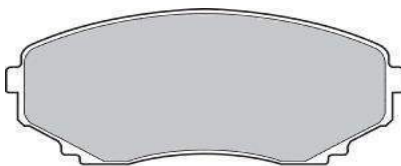

139 x 60 x 16mm
Mazda

PP625

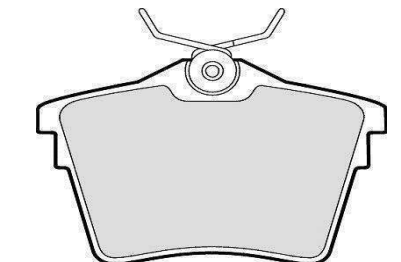

86 x 57 x 18mm
Citroën, Peugeot

PP626

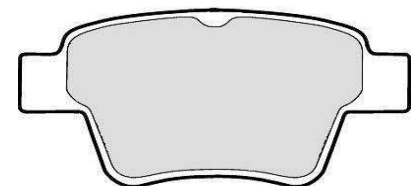

95 x 47 x 17.5mm
Citroën, Peugeot

BRAKE PADS

PP628

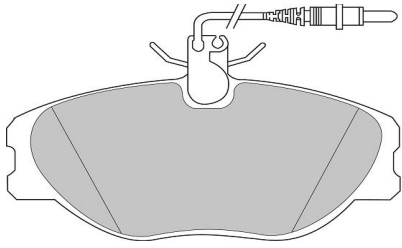

130 x 59 x 19mm

Citroën, Fiat, Lancia, Peugeot

PP629

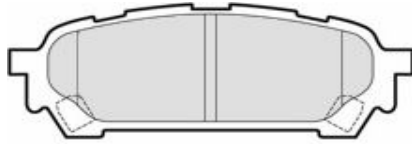

109 x 39.5 x 14mm

Subaru

PP630

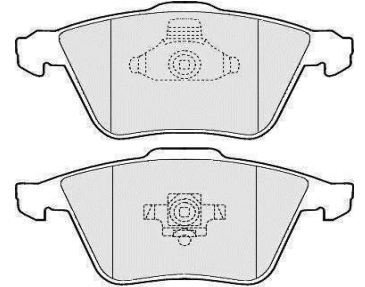

156.5/155 x 73 x 18.5mm

Ford, Mazda, Vauxhall, Volvo

PP631

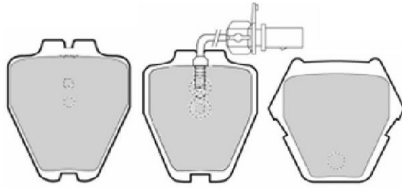

63.5/78 x 76/75 x 18mm (NB: 8pad set)

Audi, Volkswagen

PP632

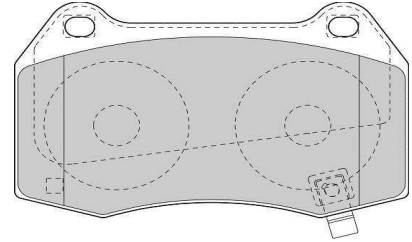

120 x 73 x 16mm

Nissan

PP633

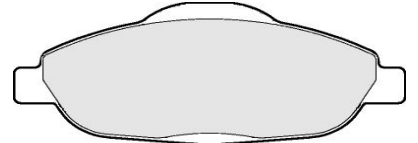

151 x 61.5 x 18mm

Peugeot

PP634

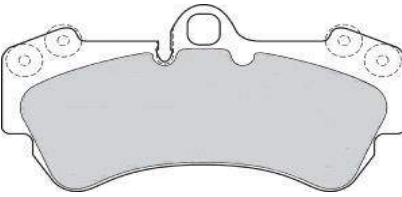

190 x 100 x 17mm

Porsche, Volkswagen

PP635

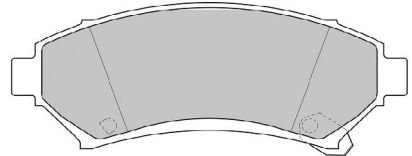

148 x 61 x 18mm

Vauxhall

PP636

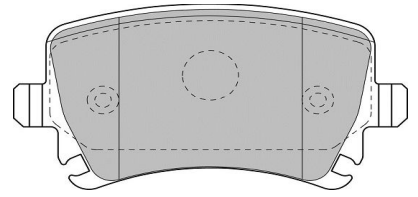

105 x 55.5 x 17mm

Audi, Seat, Skoda, Volkswagen

PP637

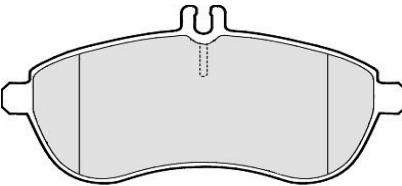

146 x 71.5 x 20.5mm

Mercedes

PP639



165 x 62 x 20.5mm

Mercedes

PP640



102 x 50 x 18mm

Mercedes

PP641

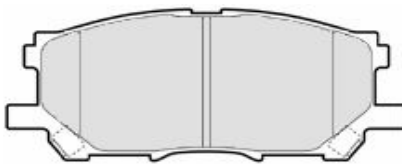

141 x 58 x 17mm

Lexus

PP642

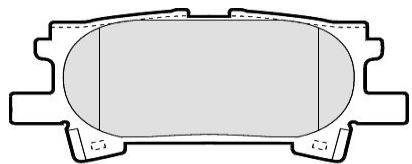

102 x 44 x 16mm

Lexus

PP643

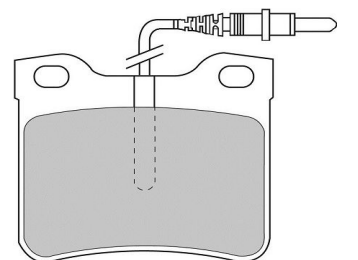

64 x 57 x 17mm

Mercedes

BRAKE PADS

PP645

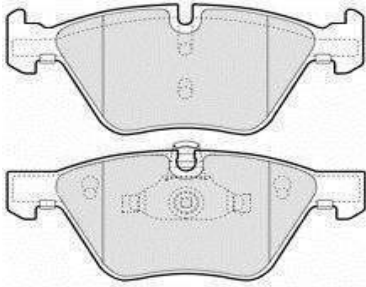

155/155.5 x 63.5 x 20mm

BMW

PP646

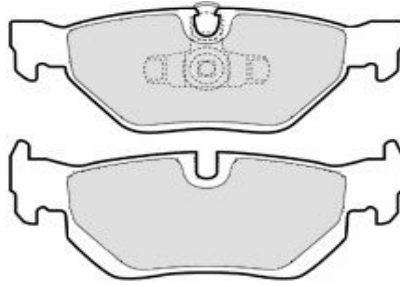

123 x 44/48 x 17.5mm

BMW

PP647

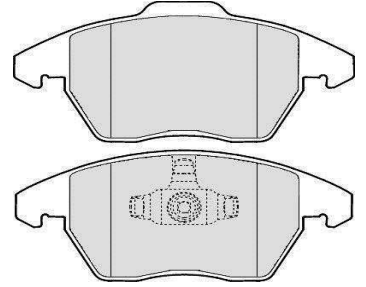

155/156.5 x 71.5/66 x 20mm

Citroën, Peugeot

PP648

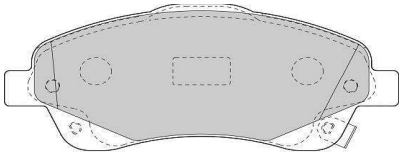

151 x 65 x 18.5mm

Toyota

PP649

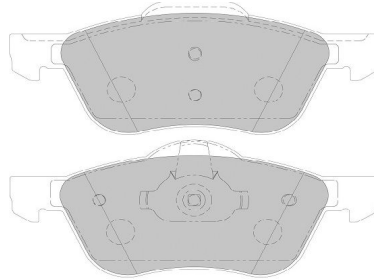

156/155 x 63/65 x 16mm

Nissan

PP650

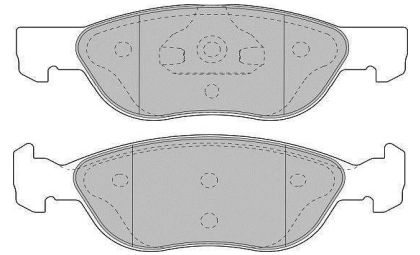

156 x 52.5 x 18mm

Fiat

PP651

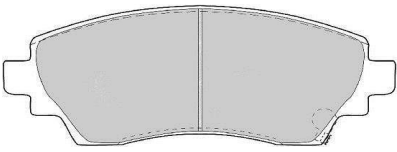

132 x 52 x 18mm

Toyota

PP654

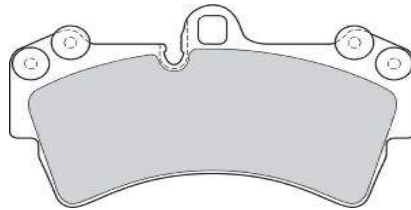

190 x 107 x 17mm

Audi, Porsche, Volkswagen

PP655

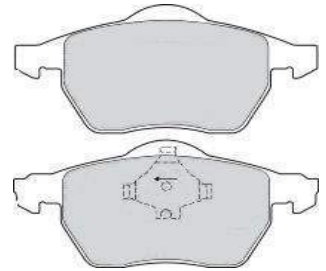

156 x 74 x 19mm

Volvo

PP657

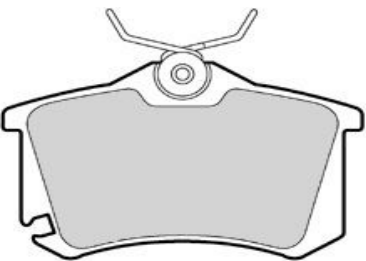

87 x 53 x 17mm

Audi, Seat, Skoda, Volkswagen

PP658

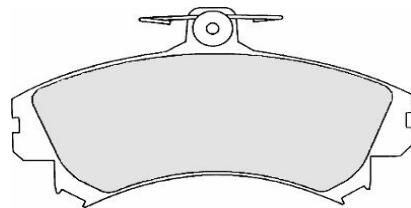

130 x 73 x 17mm

Smart

PP659

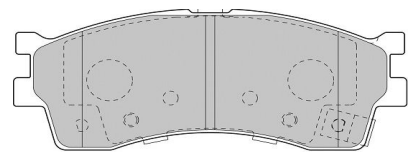

120 x 78 x 18mm

Toyota

PP660

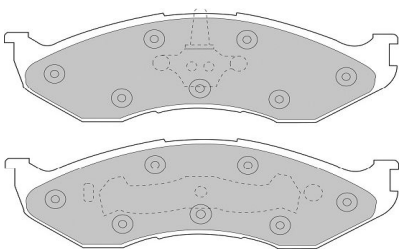

177 x 55 x 17mm

Jeep, Kia

PP661

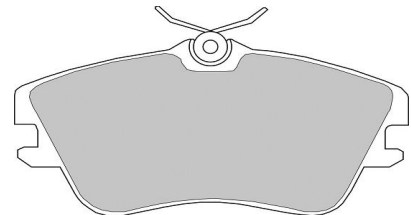

129 x 66 x 19mm

Volkswagen

PP662

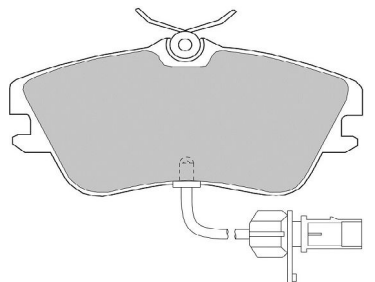

130 x 65.5 x 18.5mm

Volkswagen

BRAKE PADS

PP663

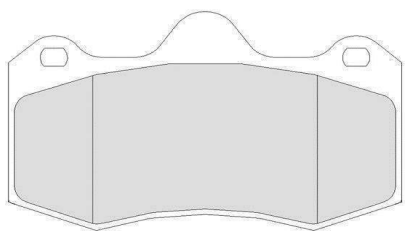

130 x 81.5 x 16.5mm

Seat

PP664

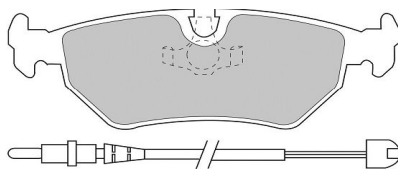

130 x 81.5 x 16.5mm

Citroën, Fiat, Lancia, Peugeot

PP665

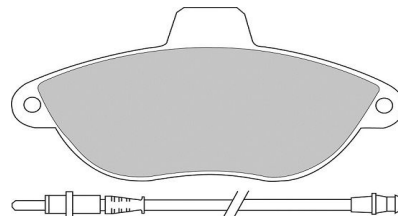

140 x 69 x 19mm

Citroën, Fiat, Peugeot

PP667

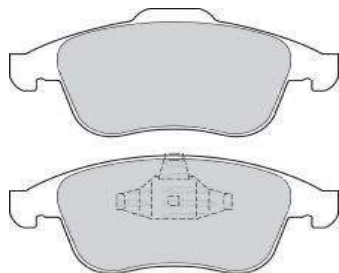

155 x 63/68 x 18mm

Renault

PP668

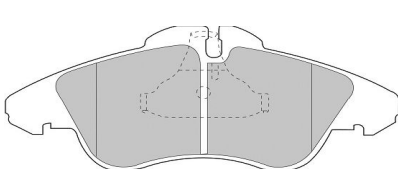

156.5 x 65 x 20.5mm

Mercedes

PP669

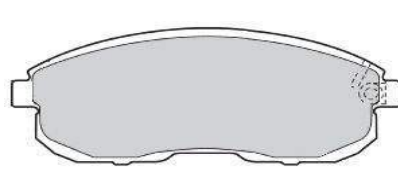

137 x 54 x 17mm

Nissan, Suzuki

PP670

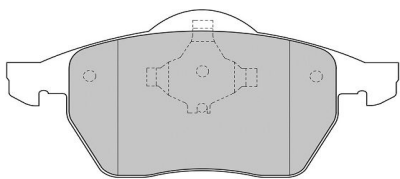

156 x 74 x 20.5mm

Seat, Ford

PP671

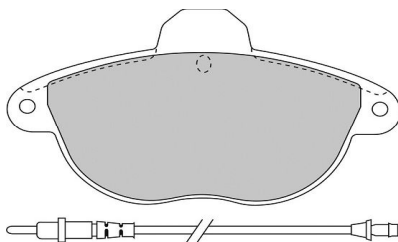

131 x 71 x 17mm

Citroën

PP672

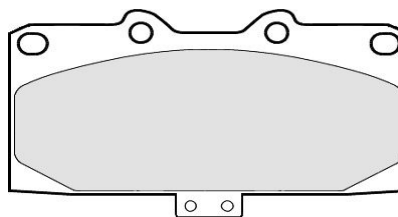

119 x 71 x 15mm

Nissan

PP673

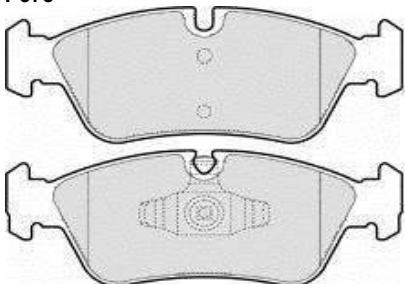

149/150 x 57.5 x 17.5mm

BMW

PP674

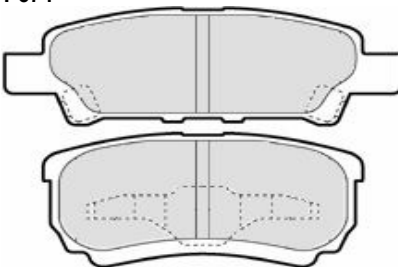

106/85.5 x 35.5/40 x 15mm

Dodge, Jeep, Mitsubishi

PP675

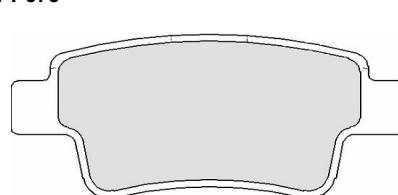

102 x 47.5 x 17.5mm

Fiat, Vauxhall

PP676

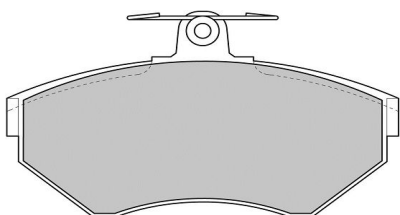

119 x 69 x 16mm

Seat, Volkswagen

PP677

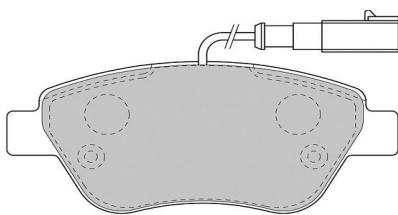

123 x 53.5 x 17mm

Alfa Romeo, Citroën, Fiat

PP678



123 x 53 x 18mm

Vauxhall

BRAKE PADS

PP680

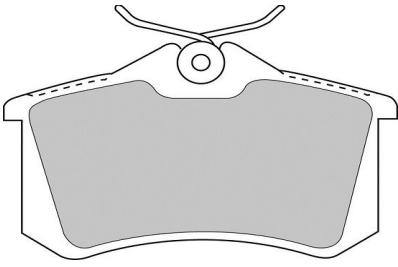

87 x 53 x 17mm

Audi, Citroën, Fiat, Lancia, Seat, VW

PP681

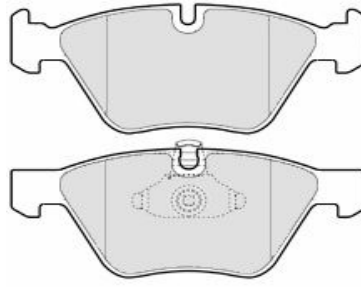

154.5/155.5 x 63.5 x 20mm

BMW

PP682

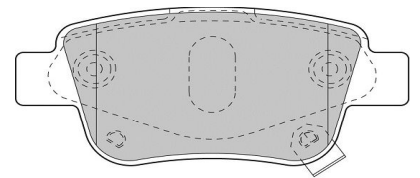

102 x 46 x 16.5mm

Toyota

PP683

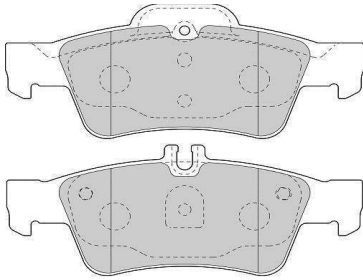

141.5 x 59.5 x 16.5mm

Mercedes

PP684

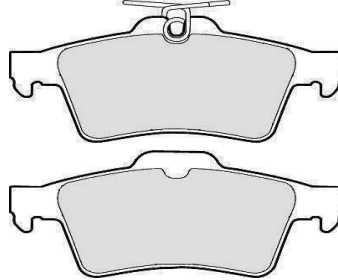

123 x 52 x 16.5mm

Various Inc; Citroën, Ford, Renault, Vauxhall

PP685

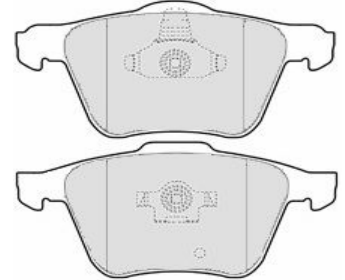

155/156.5 x 75/76 x 20mm

Volvo

PP686

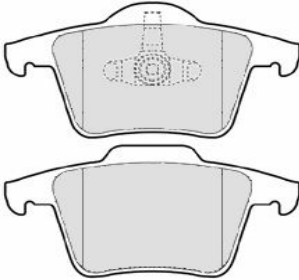

123 x 61.5/63.5 x 19mm

Volvo

PP687

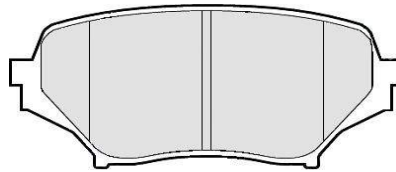

123 x 59 x 14.5mm

Mazda

PP688

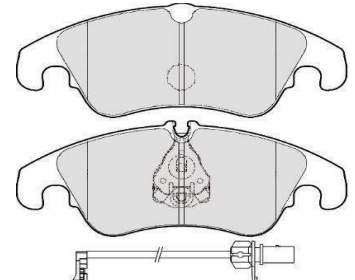

188 x 73/73.5 x 19.5mm

Audi

PP689

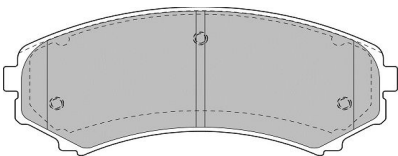

139 x 58.5 x 15mm

Mitsubishi

PP690

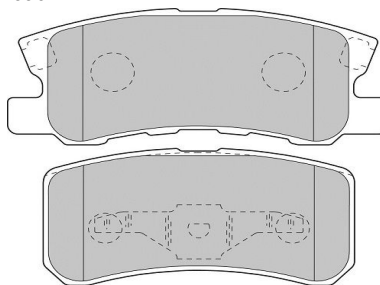

111.5/91 x 44/45 x 15.5mm

Chrysler, Citroën, Dodge, Mitsubishi, Peugeot

PP691

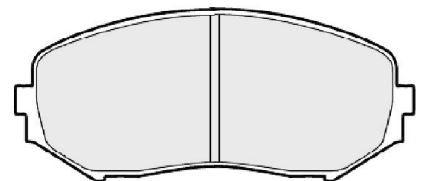

138 x 55 x 17mm

Suzuki

PP692

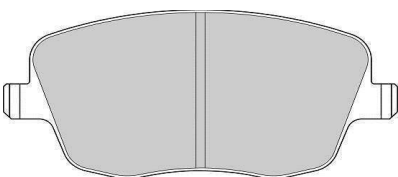

131 x 63 x 19mm

Skoda

PP693

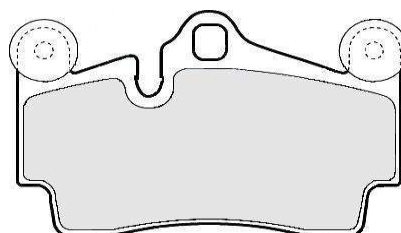

112 x 73 x 16.5mm

Audi, Porsche, Volkswagen

PP694



102 x 40 x 13mm

Mazda

BRAKE PADS

PP695

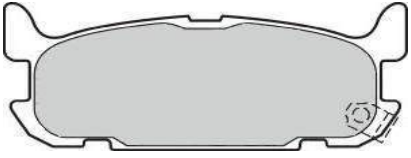

102 x 43 x 13.5mm

Mazda

PP696

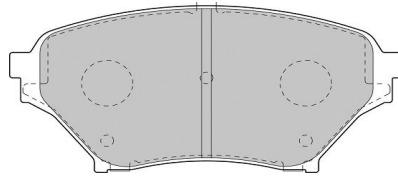

123 x 58 x 16mm

Mazda

PP697

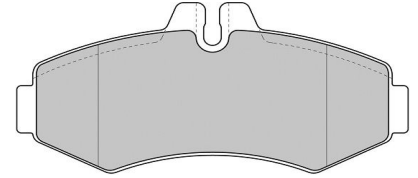

135 x 65 x 21mm

Mercedes

PP698

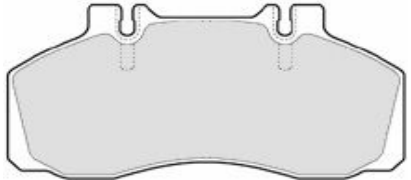

175 x 85.5 x 22mm

Mercedes

PP699



89 x 48 x 14.5mm

Honda

PP701

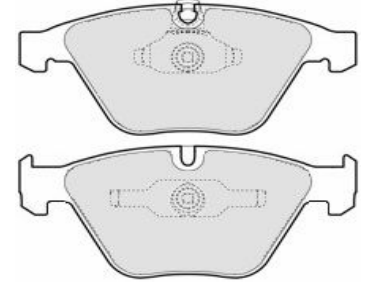

155 x 68 x 20.5mm

BMW

PP702

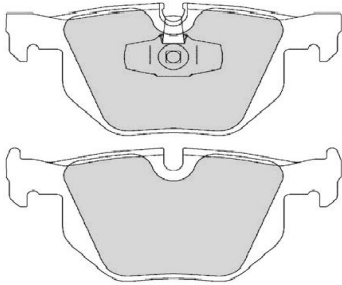

123 x 58 x 17.5mm

BMW

PP703

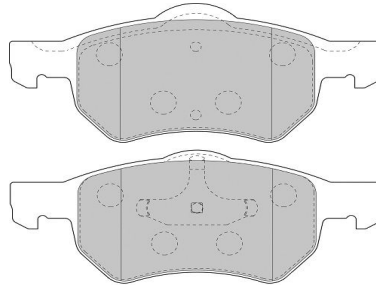

172 x 72/69 x 19mm

Chrysler

PP704

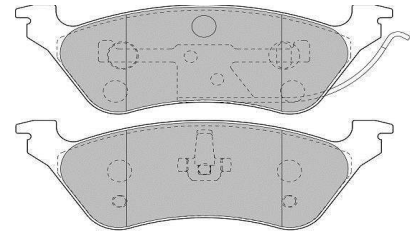

156 x 51 x 17mm

Chrysler

PP705

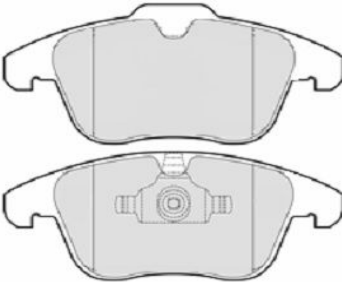

156/155 x 72/66.5 x 20/19mm

Ford, Land Rover, Volvo

PP706

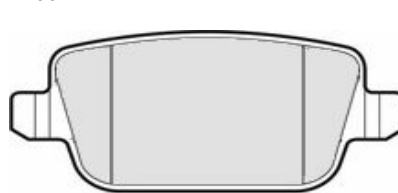

95 x 42 x 16mm

Ford, Land Rover, Volvo

PP708

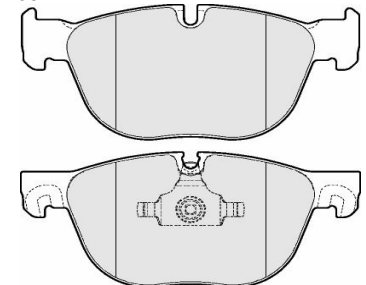

171/170 x 77 x 20mm

BMW

PP709

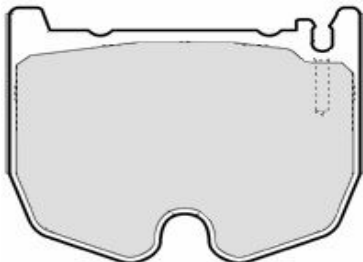

98 x 78.5 x 17.5mm

Mercedes

PP710

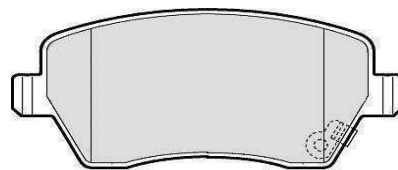

116 x 52 x 17.5mm

Nissan, Suzuki, Vauxhall

PP711

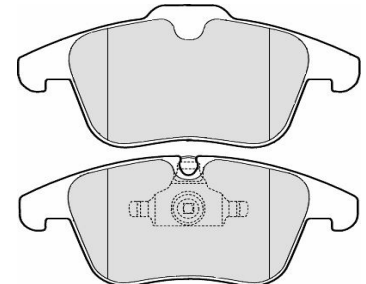

155.5/155 x 72/66.5 x 19mm

Jaguar

BRAKE PADS

PP712

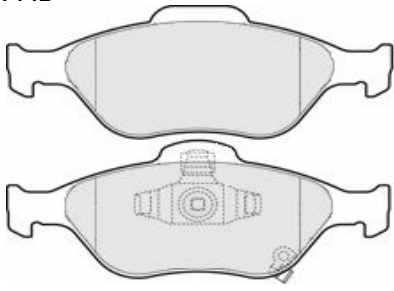

150/151 x 61/58.5 x 18mm

Toyota

PP713

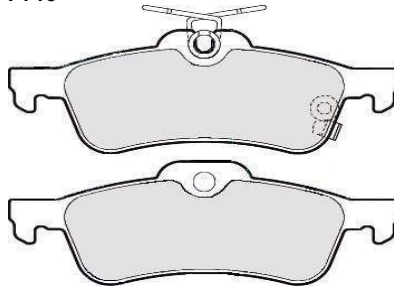

123 x 44 x 15.5mm

Toyota

PP714

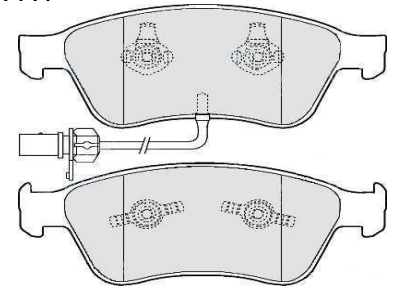

193 x 72.5 x 20.5mm

Audi, Volkswagen

PP715

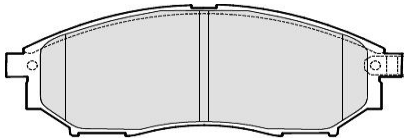

157 x 58.5 x 16.5mm

Nissan, Renault

PP716

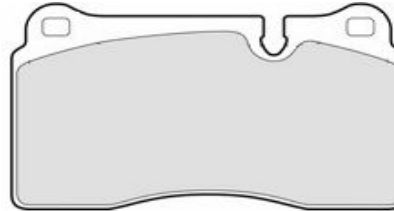

132 x 77.5 x 17mm

Land Rover

PP717

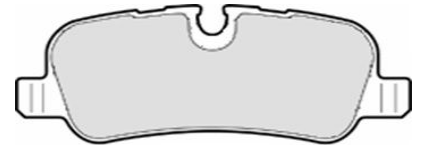

116.5 x 46.5 x 17mm

Land Rover

PP718



117 x 50 x 18mm

Alfa, Lancia

PP719

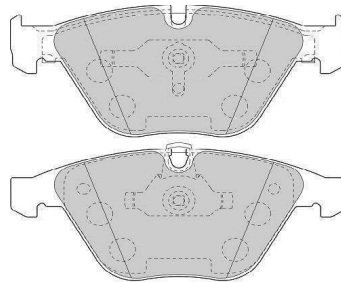

155 x 68.5 x 19.5mm

BMW

PP720

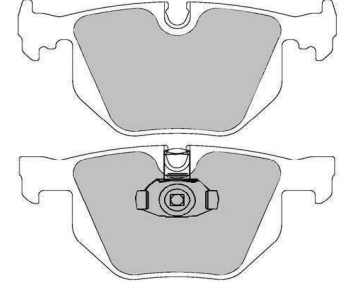

123 x 57/59.5 x 17.5mm

BMW

PP721

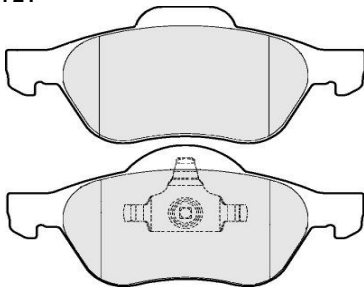

155/156 x 69/66 x 18.5mm

Renault

PP722

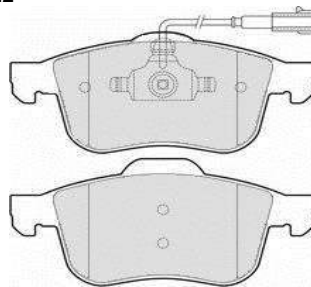

155/156 x 69/71.5 x 20.5mm

Alfa Romeo

PP725

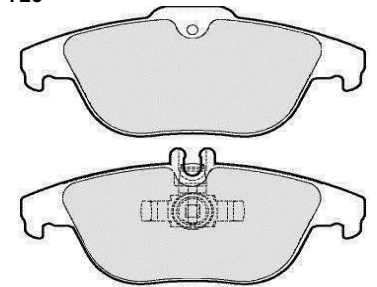

122.5 x 52.5/55.5 x 18mm

Mercedes

PP726

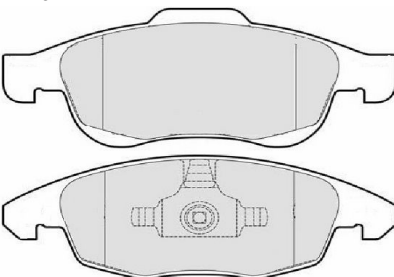

155 x 65/56 x 18mm

Citroën, Peugeot

PP728

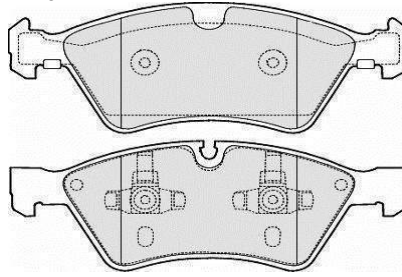

193/194 x 70 x 21mm

Mercedes

PP729

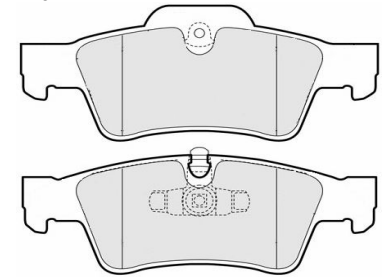

141.5/140.5 x 59.5/52 x 17.5mm

Mercedes

BRAKE PADS

PP730

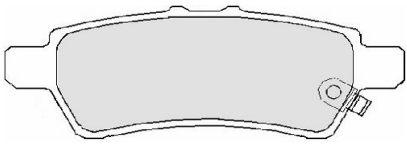

110.5 x 41 x 16mm
Nissan

PP731

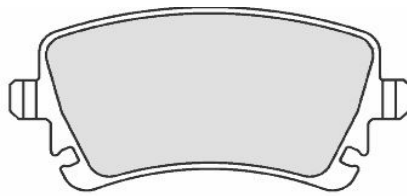

116 x 59 x 16mm
Audi

PP732



131.5 x 56 x 17.5mm
Honda

PP733

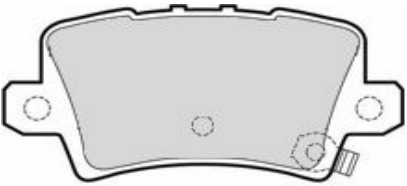

95.6 x 46.5 x 16mm
Honda

PP734

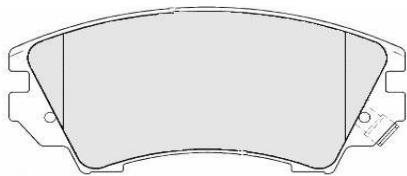

142 x 66.5 x 19mm
Vauxhall

PP735

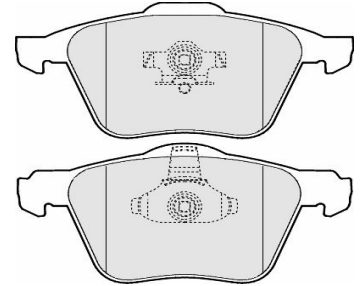

155/156 x 72/71 x 19mm
Volvo

PP738



154.5 x 59.5 x 18mm
Lexus

PP739

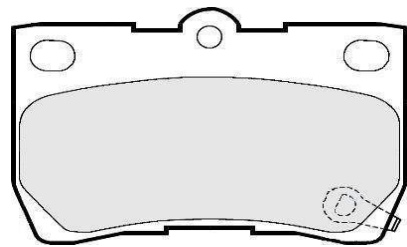

88 x 58 x 15mm
Lexus

PP740

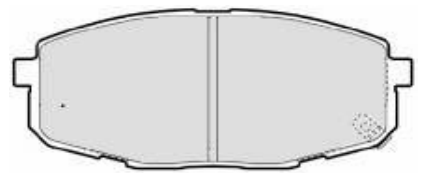

130 x 58 x 17mm
Hyundai, Kia

PP741

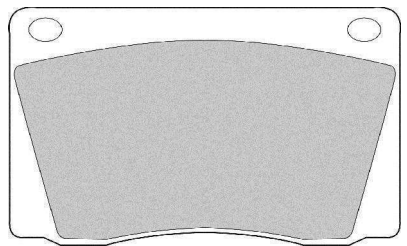

98 x 68 x 16mm
Jaguar, Reliant

PP742

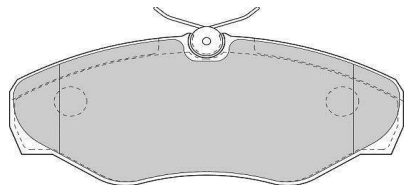

145 x 62 x 18mm
Nissan, Vauxhall

PP743

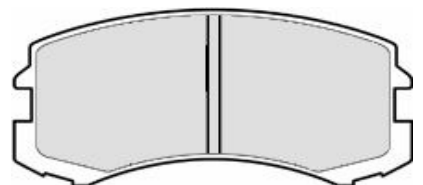

114 x 56 x 15mm
Mitsubishi

PP744

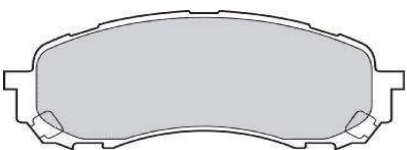

134 x 54 x 17mm
Subaru

PP745

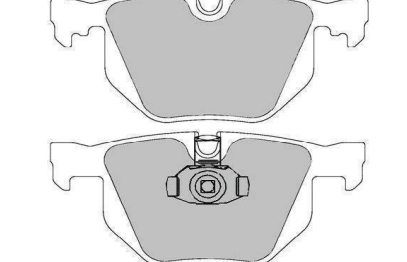

122 x 59/58 x 17.5mm
BMW

PP746

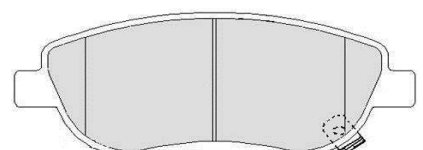

151 x 61.5 x 19.5mm
Toyota

BRAKE PADS

PP748

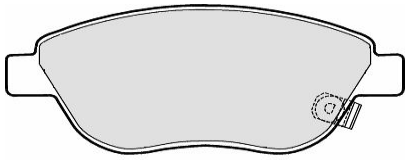

137 x 57.5 x 20mm
Vauxhall

PP749

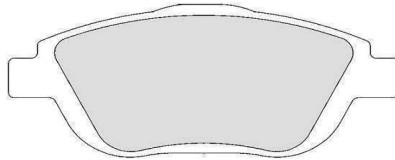

137 x 59 x 18.5mm
Citroën

PP750

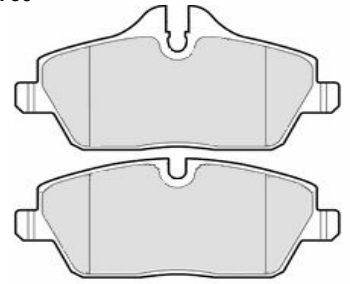

131.5 x 65/52 x 17.5mm
BMW

PP751

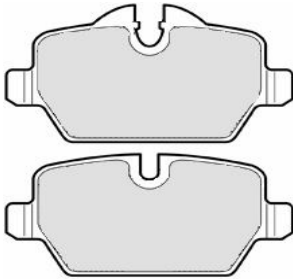

95.5 x 52/45 x 17.5mm
BMW

PP752

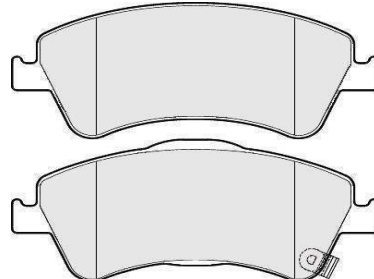

151 x 62.5/65.5 x 19.5mm
Toyota

PP754

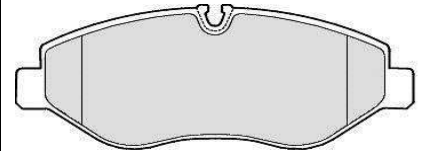

163 x 67 x 20.5mm
Mercedes

PP755



151 x 56 x 16mm
Mitsubishi

PP756

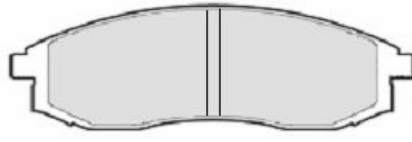

151 x 51 x 16mm
Mitsubishi

PP757

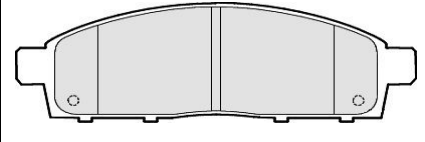

155.5 x 51 x 16.5mm
Mitsubishi

PP760

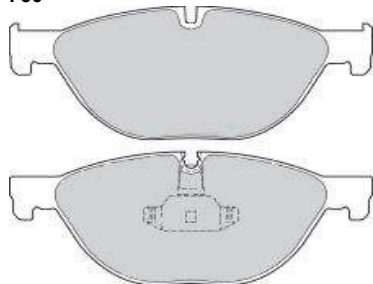

192 x 79.5 x 20/19mm
BMW

PP761

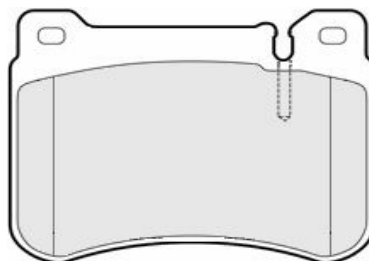

102 x 79.5 x 16.5mm
Mercedes

PP762

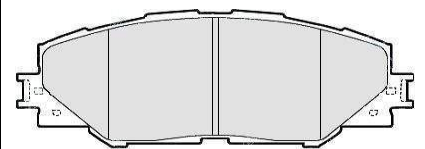

146.5 x 57 x 17.5mm
Toyota

PP763

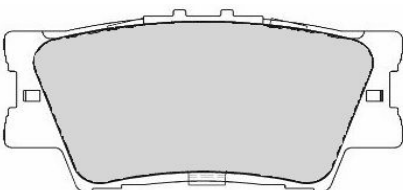

97 x 49 x 15mm
Toyota

PP764

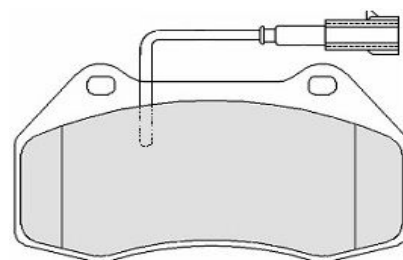

125 x 70 x 15.5mm
Alfa, Fiat

PP765

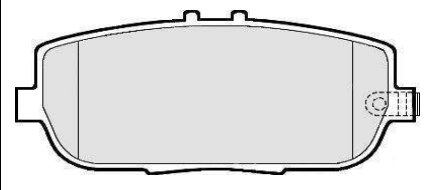

99 x 45 x 13.5mm
Mazda

BRAKE PADS

PP766

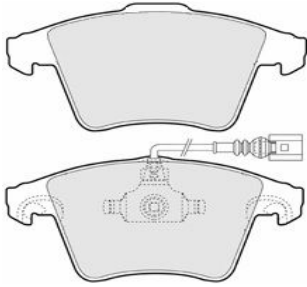

155/156 x 73/75 x 18mm
Volkswagen

PP767

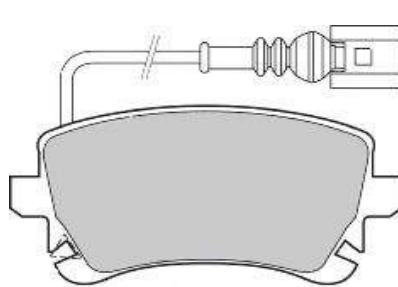

116 x 59 x 17.5mm
Volkswagen

PP769

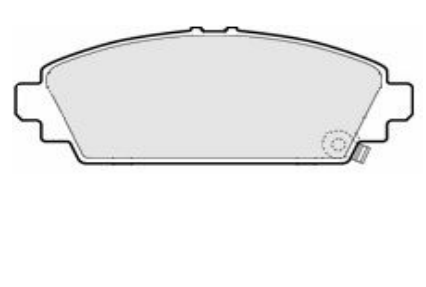

132 x 49 x 17mm
Honda

PP770

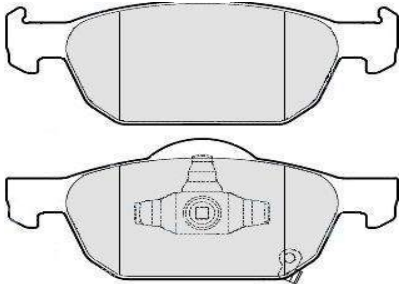

155 x 55 x 18mm
Honda

PP771

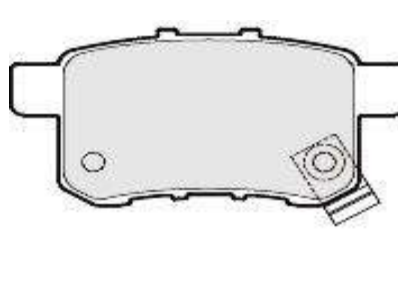

94 x 47 x 15mm
Honda

PP772

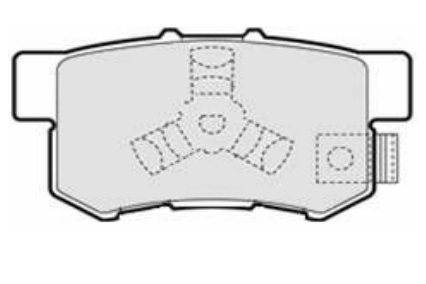

89 x 47 x 15mm
Honda

PP773

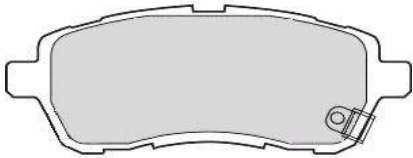

126 x 51 x 16.5mm
Daihatsu, Ford, Mazda, Suzuki

PP774

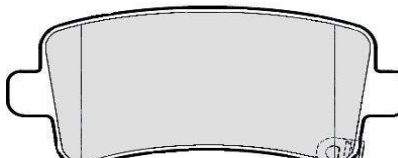

106.5 x 47 x 17mm
Vauxhall

PP775

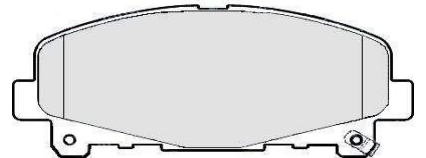

152 x 65 x 17.5mm
Honda

PP776

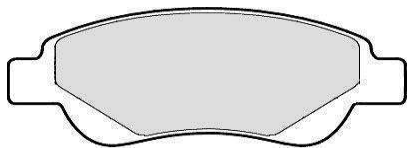

123 x 47 x 17.5mm
Citroën, Peugeot, Toyota

PP777

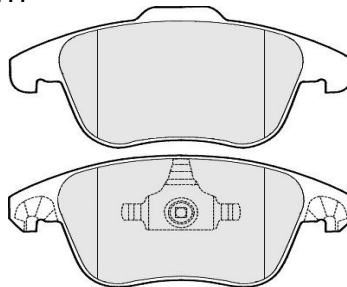

155 x 72/67 x 18.5mm
Citroën, Peugeot

PP778

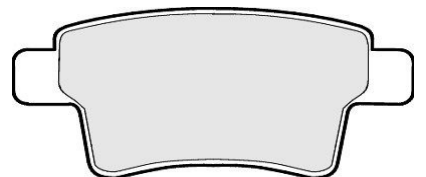

102 x 48 x 16mm
Citroën

PP779

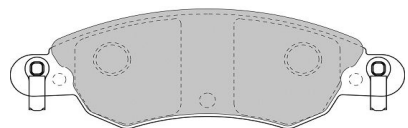

149 x 50 x 18mm
Citroën

PP780



169 x 61 x 18mm
Citroën

PP781

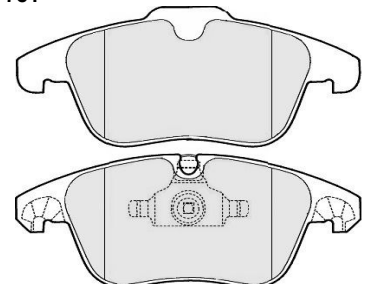

155 x 72/66.5 x 18.5mm
Citroën, Peugeot

BRAKE PADS

PP782

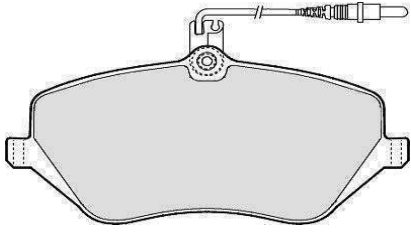

163 x 79 x 18.5mm
Citroën, Peugeot

PP784

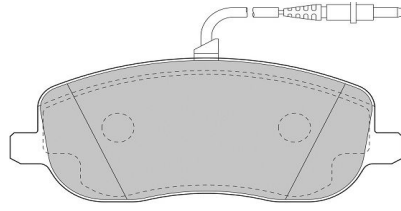

147 x 60 x 19mm
Citroën, Fiat, Lancia, Peugeot

PP785

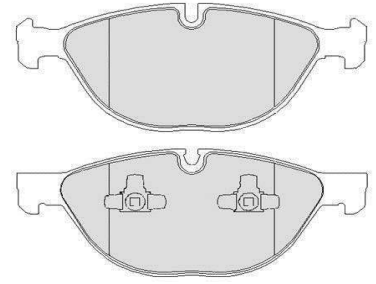

193 x 79 x 19.5/20.5mm
BMW

PP786

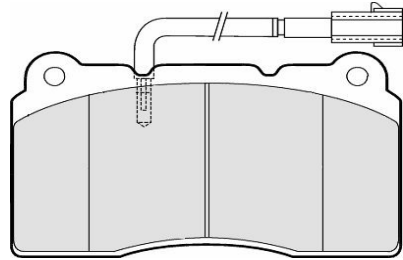

131.5 x 77 x 16mm
Alfa Romeo, Lancia

PP787

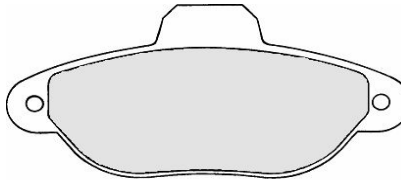

115 x 55 x 17mm
Fiat, Ford

PP788

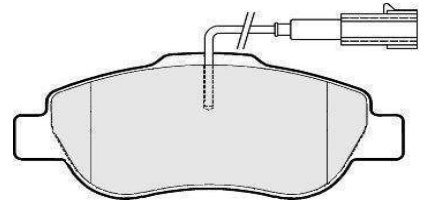

123 x 52 x 17.5mm
Fiat, Ford

PP789

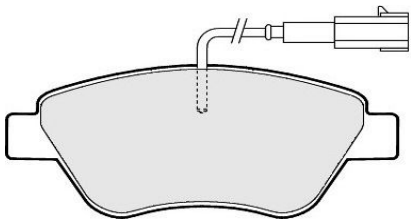

123 x 53 x 18mm
Fiat

PP790



123 x 52 x 18mm
Fiat

PP791

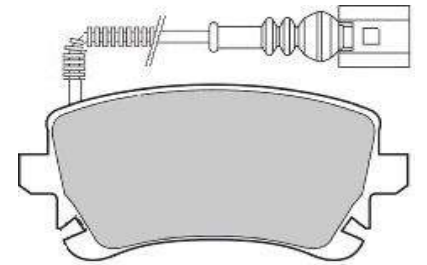

116 x 59 x 17.5mm
Audi, Volkswagen

PP792

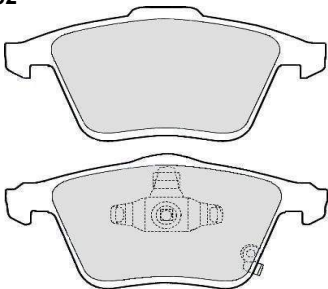

155 x 73 x 18.5mm
Mazda

PP793

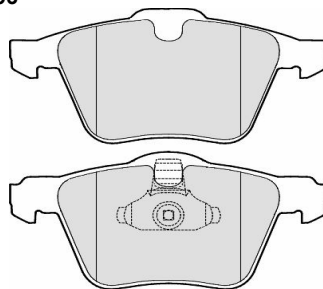

155/156 x 75/74 x 18.5mm
Ford, Volvo

PP794

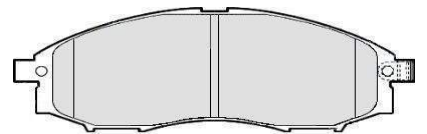

164 x 57 x 17.5mm
Nissan

PP796

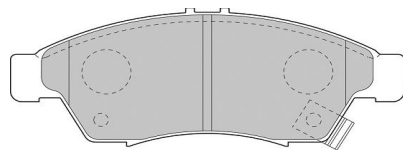

136 x 54 x 17mm
Suzuki

PP797

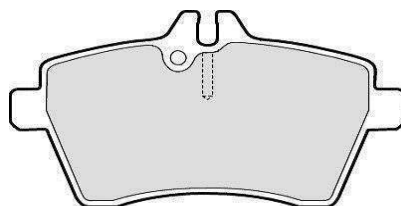

116.5 x 63.5 x 19mm
Mercedes

PP798

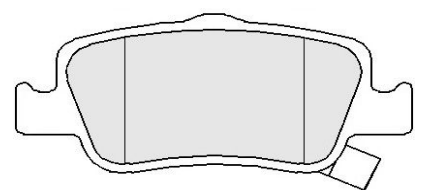

102 x 46 x 17mm
Toyota

BRAKE PADS

PP799

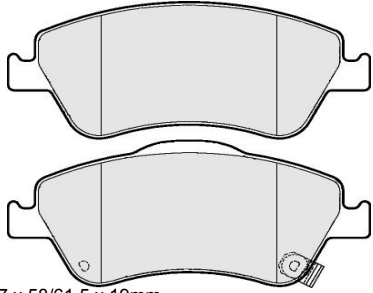

137 x 58/61.5 x 19mm

Toyota

PP800

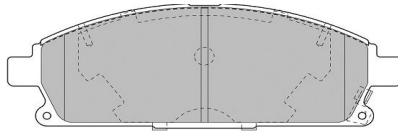

159 x 57 x 17mm

Nissan

PP801

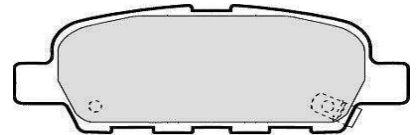

105.5 x 38 x 14mm

Nissan, Renault

PP802



162 x 58 x 18mm

Land Rover

PP803

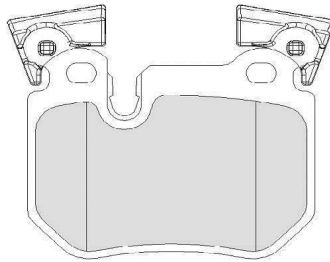

87 x 76 x 17mm

BMW

PP804

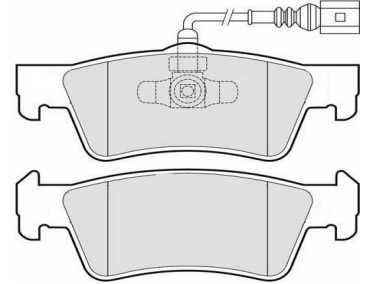

141 x 51/54 x 19mm

Volkswagen

PP805

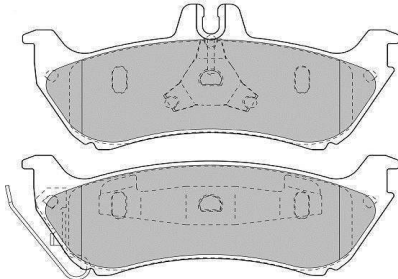

140 x 61/51 x 17mm

Mercedes

PP806

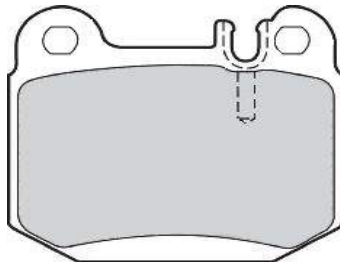

76 x 66 x 17mm

Mercedes

PP807

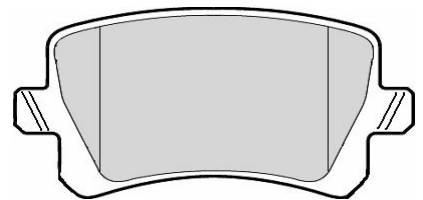

105.5 x 56.5 x 17mm

Volkswagen

PP808

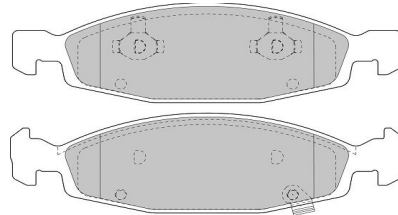

194/192 x 55 x 18mm

Jeep

PP809

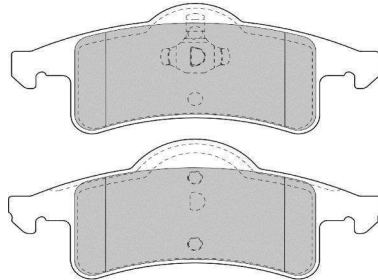

141 x 58 x 17.5mm

Jeep

PP810

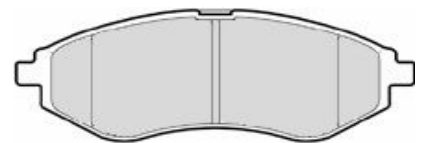

133.5 x 49 x 18mm

Chevrolet, Daewoo

PP811

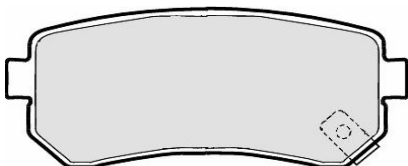

93 x 41 x 16.5mm

Hyundai, Kia

PP812

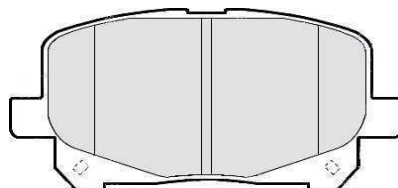

117 x 60 x 17mm

Toyota

PP813

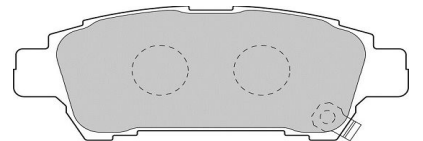

113 x 43 x 16mm

Toyota

BRAKE PADS

PP814

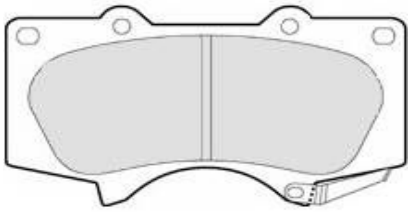

135 x 77 x 18mm
Mitsubishi, Toyota

PP815

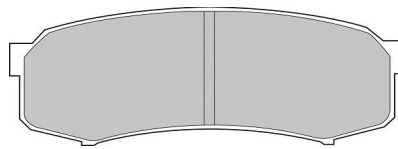

117 x 44 x 15.5mm
Mitsubishi, Toyota

PP816

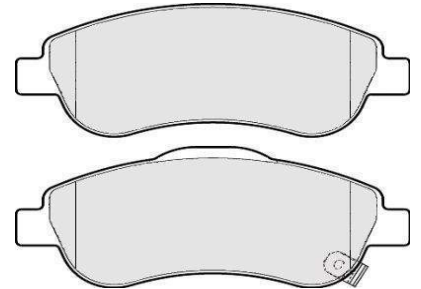

151 x 57/60 x 19mm
Honda

PP817

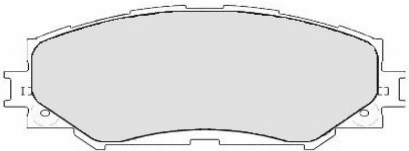

139 x 56 x 17mm
Toyota

PP818

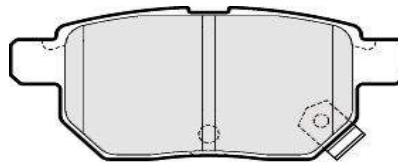

98.5 x 42.5 x 15mm
Toyota, Lexus

PP819

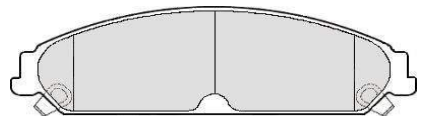

183.5 x 54.5 x 17.5mm
Chrysler

PP820

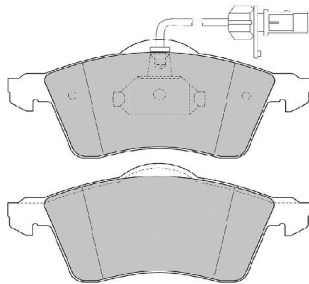

156.5 x 68.5 x 19.5mm
Volkswagen

PP821

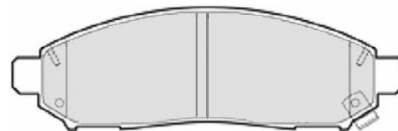

164 x 54 x 16.5mm
Nissan

PP822

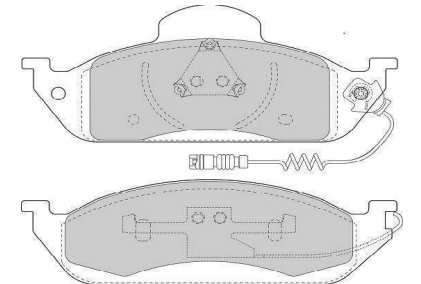

188 x 77/59 x 16/17mm
Mercedes

PP823

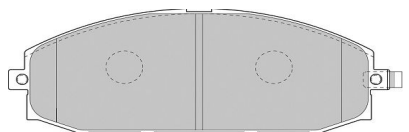

166 x 61 x 19mm
Nissan

PP824

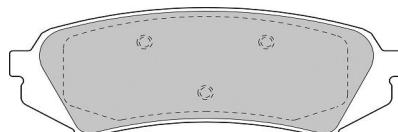

124 x 46 x 17mm
Toyota

PP825

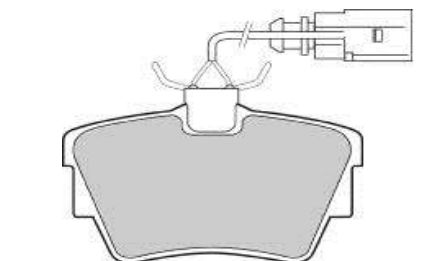

94.5 x 59 x 17mm
Volkswagen

PP826



169 x 67 x 19mm
Ford

PP827

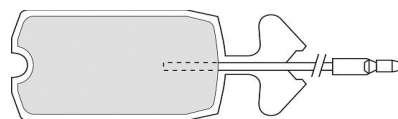

89 x 38 x 12mm
Citroën

PP828



80 x 58 x 14mm
Toyota

BRAKE PADS

PP829

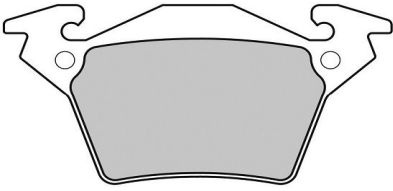

104 x 53 x 18mm
Mercedes

PP830

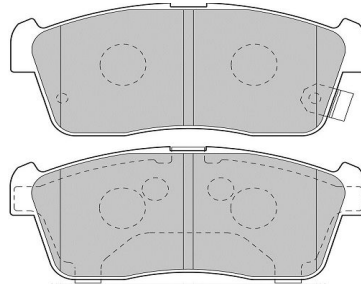

109 x 45 x 15mm
Daihatsu, Nissan, Subaru, Suzuki

PP831

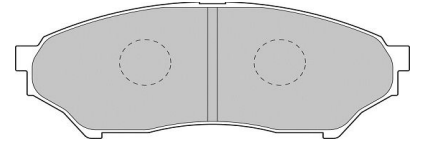

123 x 48 x 16mm
Mitsubishi

PP832



152 x 62 x 17mm
Ford

PP833

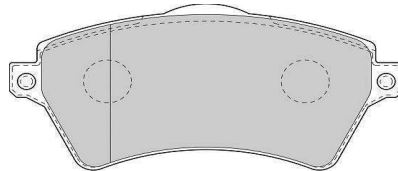

132 x 62 x 18mm
Land Rover

PP834

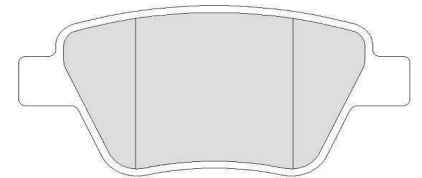

109.5 x 53.5 x 17.5mm
Audi, Seat, Skoda, Volkswagen

PP835

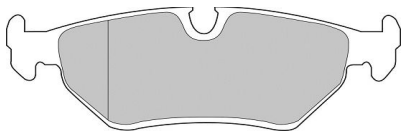

123 x 43 x 17mm
Jaguar

PP836

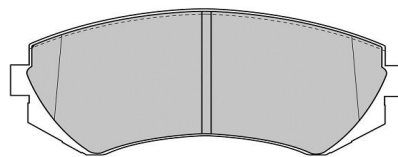

121 x 50 x 16mm
Nissan

PP837

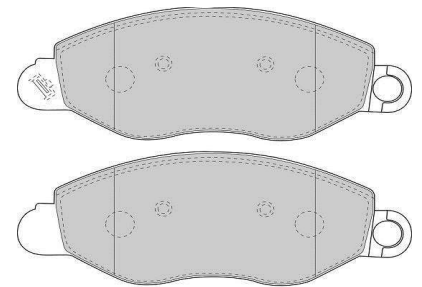

168 x 64 x 17mm
Ford

PP838

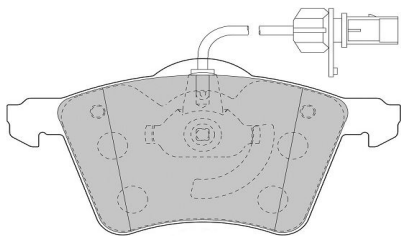

156.5 x 79 x 18mm
Ford, Seat, Volkswagen

PP839

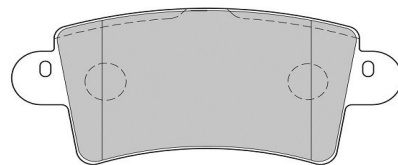

116 x 51 x 17mm
Nissan, Vauxhall

PP840

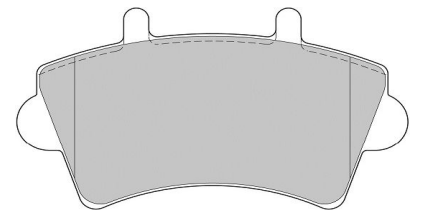

139 x 80 x 18mm
Nissan, Vauxhall

PP841

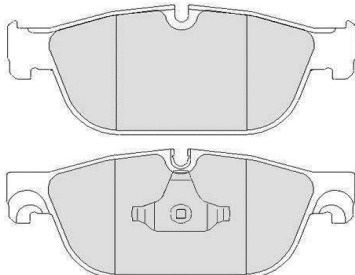

180 x 75 x 17mm
Citroën, Peugeot

PP842

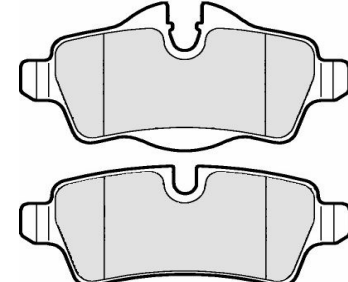

95 x 48/39 x 16mm
Mini

PP844

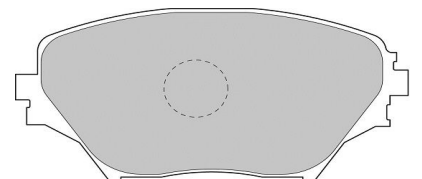

123 x 60 x 18mm
Toyota

BRAKE PADS

PP845

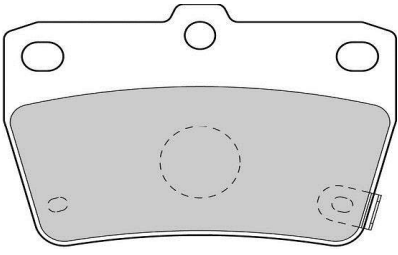

79 x 54 x 14mm

Toyota

PP846

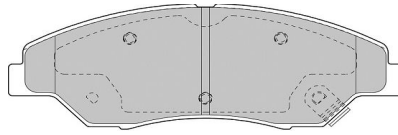

149 x 53 x 16mm

Kia

PP847



131 x 47 x 18mm

Nissan

PP848

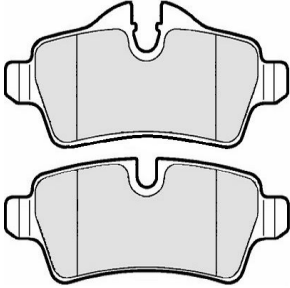

131.5 x 71.5/64 x 18mm

Mini

PP849

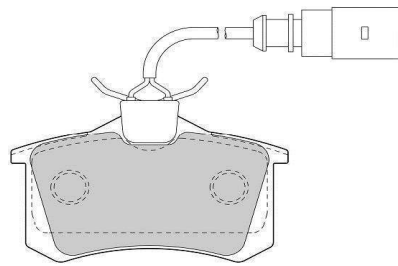

87 x 53 x 17mm

Ford, Volkswagen

PP850

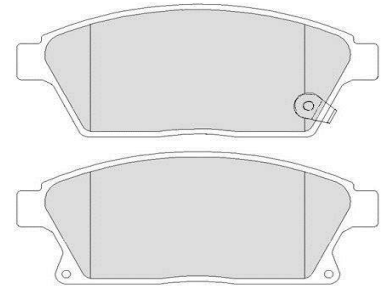

148 x 61 x 19mm

Chevrolet, Vauxhall

PP851

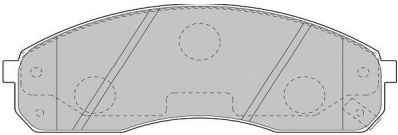

154 x 57 x 17mm

Kia

PP853

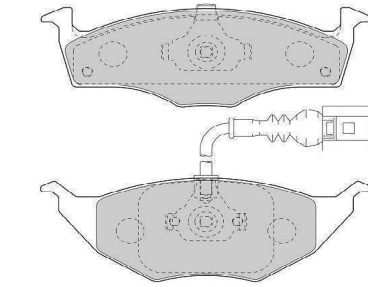

142 x 48/50 x 14mm

Audi

PP854

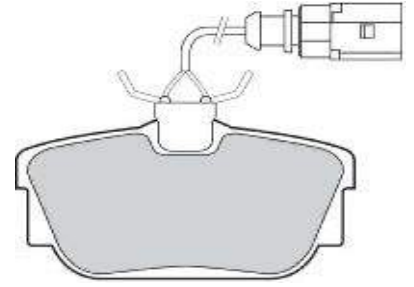

95 x 51 x 16mm

Ford, Seat, Volkswagen

PP855

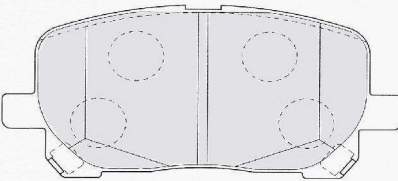

123 x 60 x 17mm

Toyota

PP856



83 x 39 x 15mm

Toyota

PP857

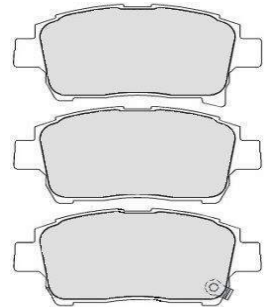

116 x 54/51 x 16mm

Toyota

PP858

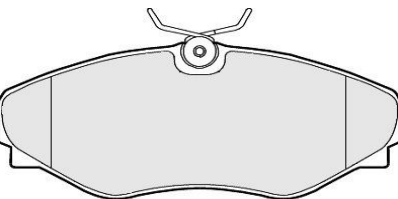

144 x 62 x 18mm

Renault

PP859

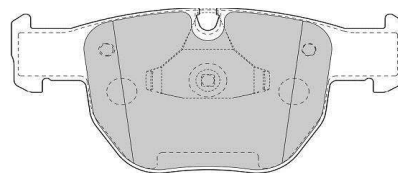

156.5 x 73.5 x 19.5mm

Land Rover

PP860

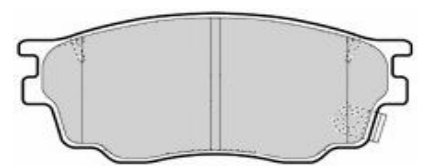

132 x 56 x 17mm

Mazda

BRAKE PADS

PP861

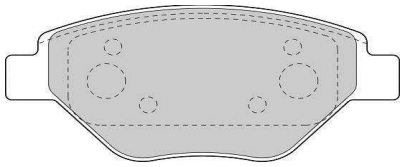

123 x 54 x 18mm
Renault

PP862

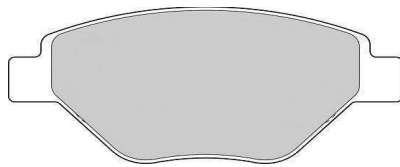

139 x 59 x 15mm
Nissan

PP863

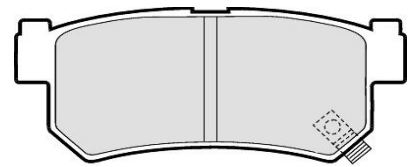

99 x 43 x 16mm
Daewoo, Ssangyong

PP864

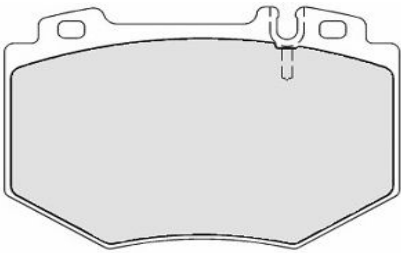

119 x 83 x 17mm
Mercedes

PP865

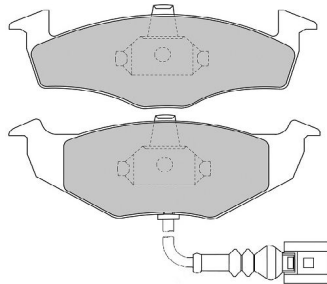

142 x 51 x 17mm
Skoda, Volkswagen

PP867

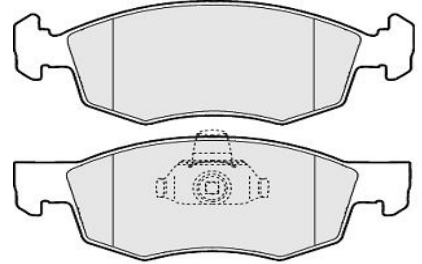

151/150 x 53 x 18mm
Fiat

PP868

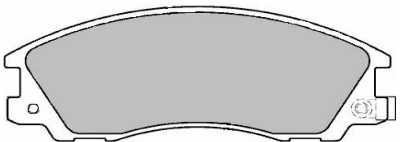

149 x 58 x 17mm
Hyundai

PP869

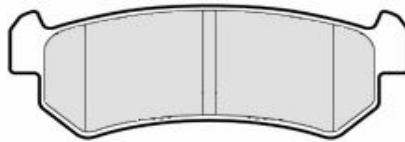

105 x 39 x 15mm
Chevrolet, Daewoo

PP870

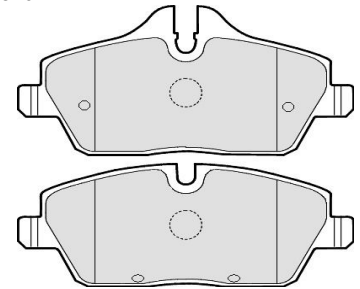

131 x 65/53 x 17mm
Mini

PP871



156 x 60 x 17mm
Kia

PP872

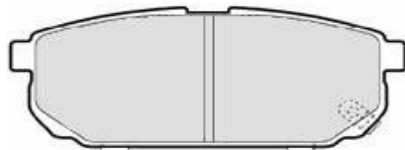

118 x 47 x 16mm
Kia

PP873



110 x 46 x 16mm
Hyundai

PP874

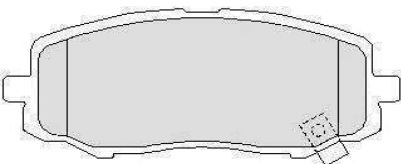

116 x 47 x 17mm
Hyundai, Kia

PP875



92 x 41 x 15mm
Hyundai, Kia

PP876

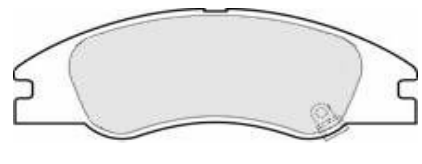

165 x 59 x 17mm
Kia

BRAKE PADS

PP877

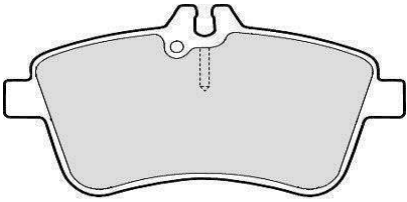

132 x 70 x 20mm

Mercedes

PP878



139 x 53 x 16mm

Daewoo, Ssangyong

PP880

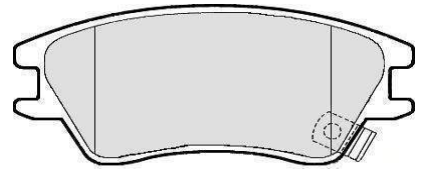

105 x 47 x 16mm

Hyundai

PP881



131 x 44 x 16mm

Subaru, Suzuki

PP882

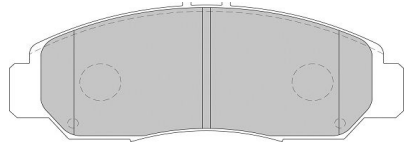

149 x 59.5 x 17.5mm

Honda

PP883

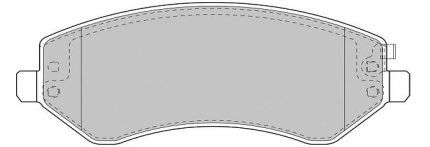

147 x 60 x 18mm

Chrysler, Jeep

PP884

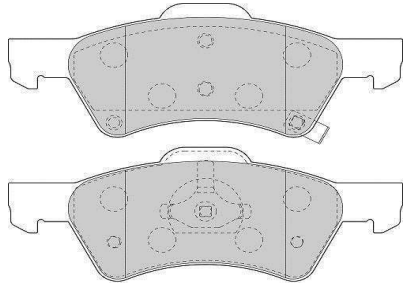

172.5 x 65 x 19.5mm

Chrysler, Jeep

PP885

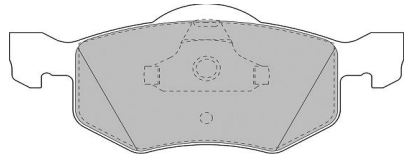

156 x 67 x 20mm

Ford, Mazda

PP887

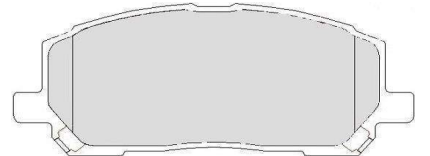

139 x 60 x 19mm

Lexus

PP889

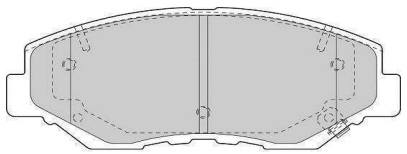

142 x 57 x 18mm

Honda

PP890

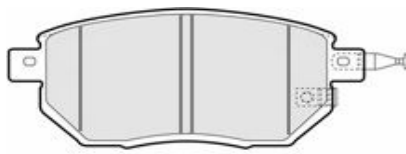

136 x 66 x 15mm

Nissan

PP891



158 x 60.5 x 19mm

Jeep

PP892

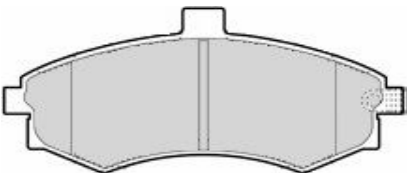

137 x 63 x 18mm

Hyundai

PP893

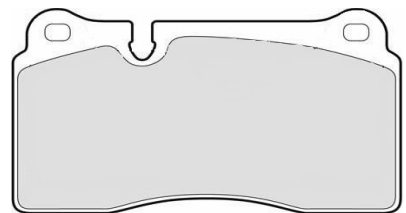

131.5 x 77.5 x 16.5mm

Volkswagen

PP894

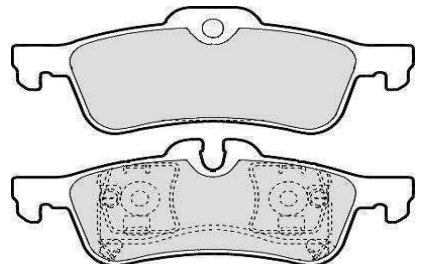

123 x 44 x 17mm

Mini

BRAKE PADS

PP895

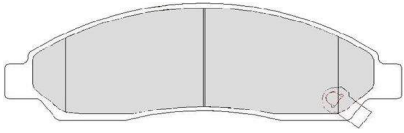

167.5 x 54.5 x 17mm
Isuzu

PP897

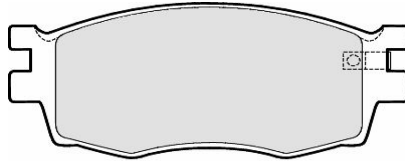

129.5 x 56 x 18mm
Hyundai, Kia

PP899

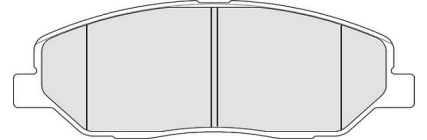

156 x 61 x 17mm
Hyundai, Kia

PP900

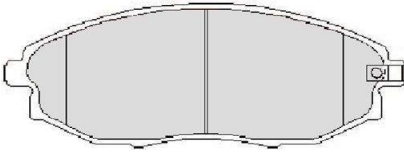

144 x 56.5 x 17mm
Chevrolet

PP901

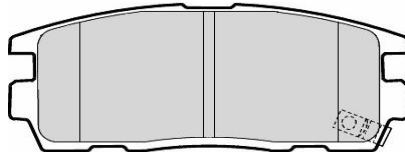

110 x 46 x 15mm
Chevrolet, Vauxhall

PP902



110 x 48 x 15mm
Hyundai, Kia

PP903

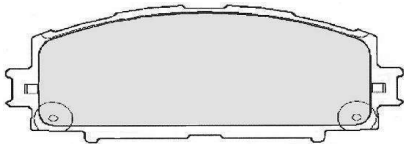

123 x 50 x 18.5mm
Lexus, Toyota

PP906

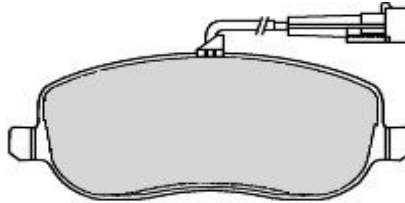

146.5 x 60 x 19mm
Fiat

PP907



105.5 x 45.5 x 17mm
Fiat

PP908

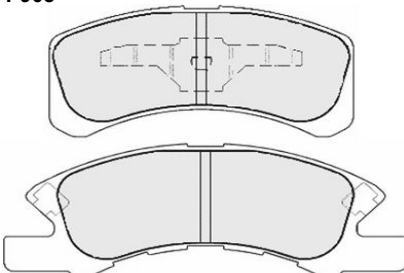

92/122 x 44 x 15mm
Daihatsu

PP909

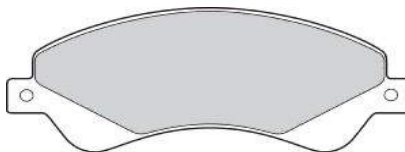

165 x 65.5 x 18.5mm
Ford

PP910

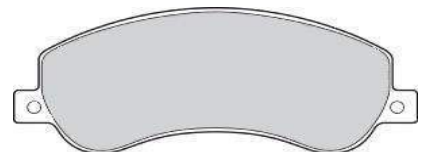

165 x 66.5 x 19mm
Ford, Volkswagen

PP911



123 x 54 x 17.5mm
Ford

PP912

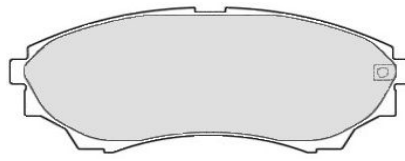

145 x 59 x 16mm
Ford

PP913

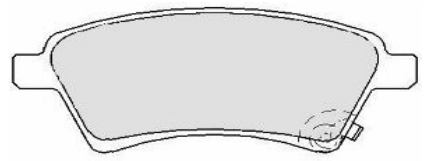

132 x 57 x 16mm
Fiat, Suzuki

BRAKE PADS

PP914

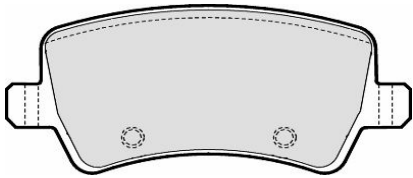

106 x 48.5 x 16mm
Ford, Volvo

PP915

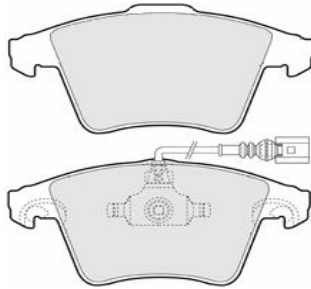

155 x 75/73 x 20mm
Volkswagen

PP916

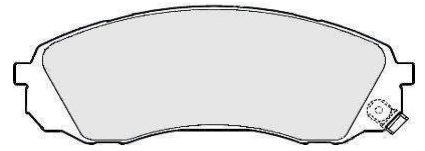

164.5 x 63.5 x 18mm
Hyundai, Kia

PP917

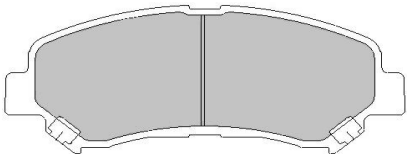

141.5 x 58.5 x 17mm
Nissan, Renault

PP918

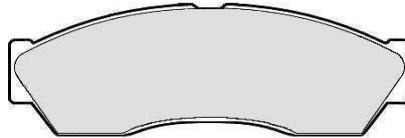

121 x 45 x 16mm
Rover

PP919

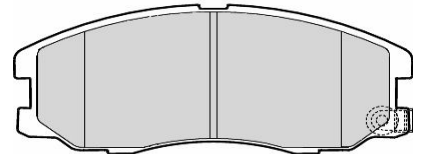

149 x 62 x 17mm
Chevrolet, Vauxhall

PP920

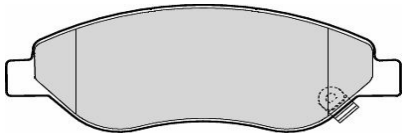

150.5 x 55 x 20mm
Vauxhall

PP921

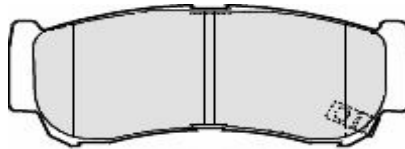

119 x 47 x 16mm
Hyundai

PP922

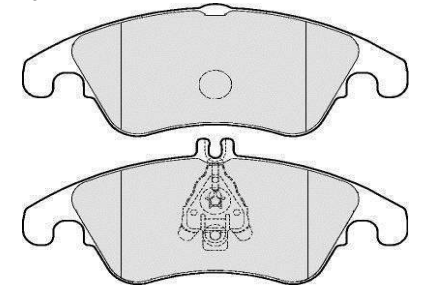

188 x 73.5/80.5 x 19.5mm
Mercedes

PP923

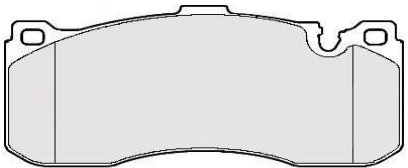

163 x 73 x 16.5mm
BMW

PP924

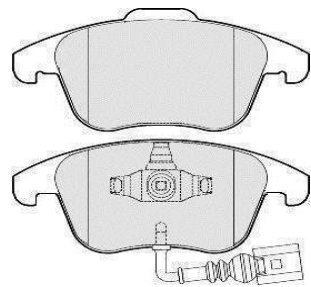

155 x 72/66.5 x 20.5mm
Seat, Volkswagen

PP925



184.5 x 66 x 17mm
Vauxhall

PP926

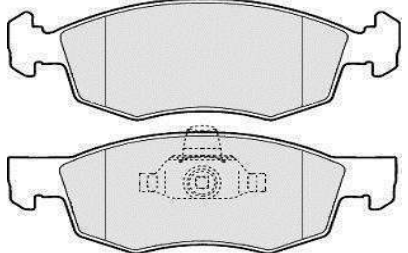

150/151 x 52.5 x 18mm
Dacia

PP927

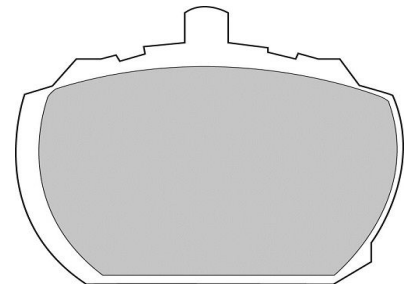

88 x 71 x 15mm
Ford, Reliant

PP929

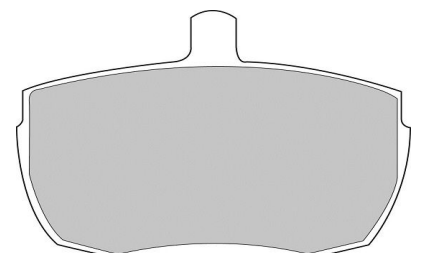

105 x 75 x 18mm
Ford

BRAKE PADS

PP933

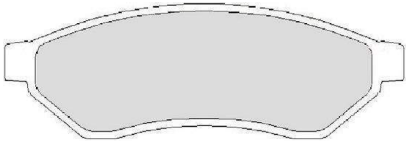

121 x 37 x 15mm
Chevrolet

PP934

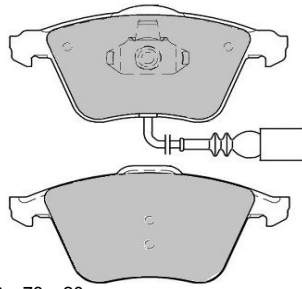

155/156 x 73 x 20mm
Audi, Volkswagen

PP935

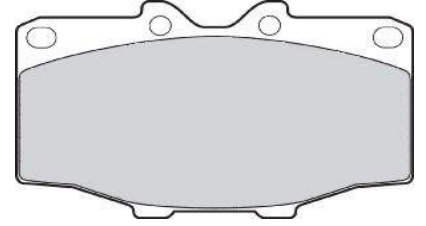

107 x 66 x 15mm
Toyota

PP936

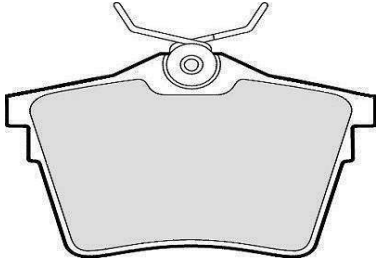

87 x 53 x 17mm
Citroën, Peugeot

PP937

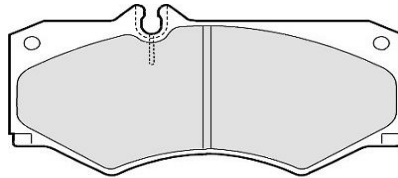

149 x 75 x 18mm
Mercedes

PP938

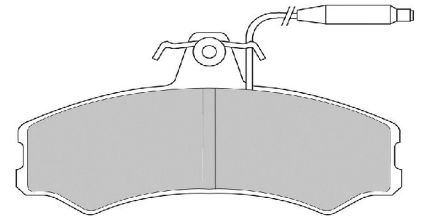

130 x 72 x 19mm
Talbot

PP939

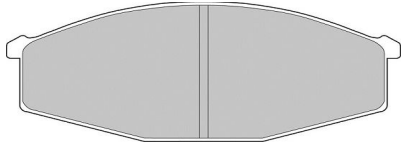

142 x 53 x 16mm
Nissan

PP940

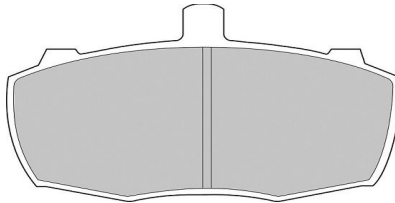

127 x 73 x 18mm
Land Rover

PP941



109 x 42 x 16mm
Honda

PP942



111 x 41 x 15mm
Suzuki

PP943



100 x 41 x 15mm
Hyundai, Kia, Vauxhall

PP944



143 x 55 x 16mm
Toyota

PP946

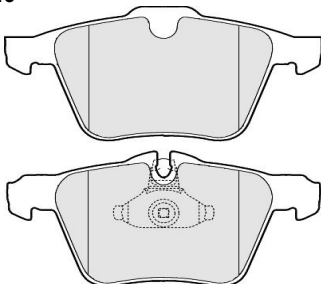

155/156.5 x 75.5/74.5 x 19mm
Jaguar

PP947



140 x 49 x 15mm
Jeep

PP948

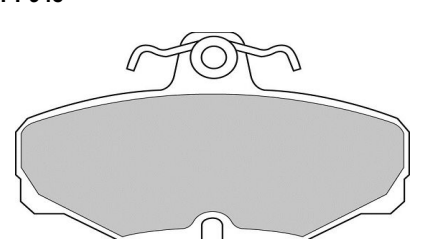

90 x 54 x 13.5mm
Westfield

BRAKE PADS

PP949

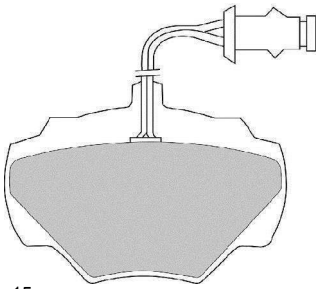

89 x 72 x 15mm
Land Rover

PP950

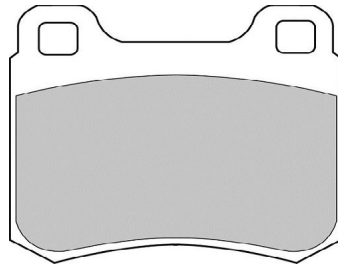

62 x 54 x 15mm
Mercedes

PP951

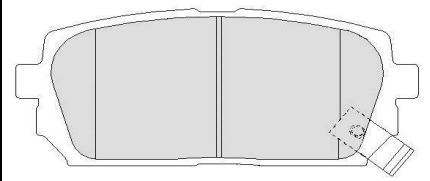

101 x 44 x 15mm
Kia

PP952

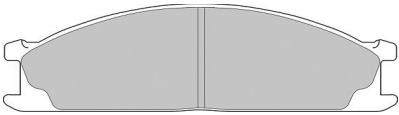

161 x 50 x 17mm
Ford, Nissan

PP953

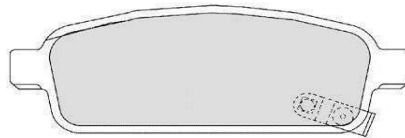

116 x 42.5 x 16mm
Chevrolet, Vauxhall

PP954

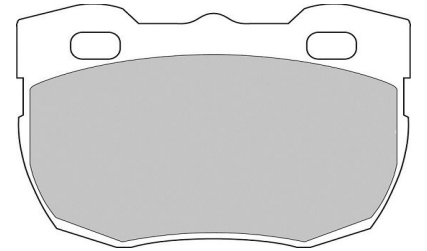

105 x 72 x 18mm
Land Rover

PP955

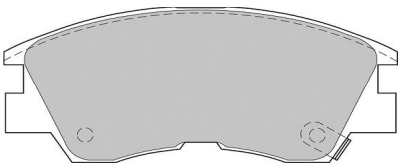

128 x 55 x 15mm
Mitsubishi

PP956

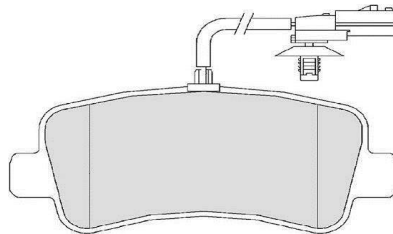

128.5 x 60 x 18mm
Renault, Vauxhall

PP957

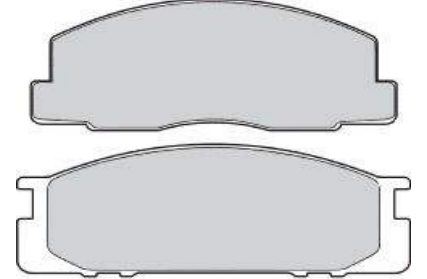

128/137 x 52 x 15mm
Toyota

PP958

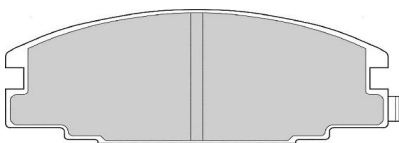

127 x 51 x 16mm
Isuzu, Vauxhall

PP959

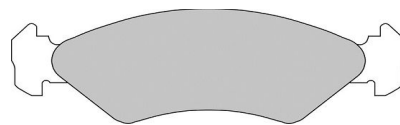

141 x 45 x 17mm
Ford

PP960

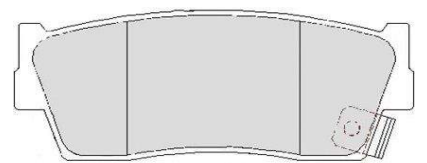

103 x 43 x 15mm
Suzuki

PP961

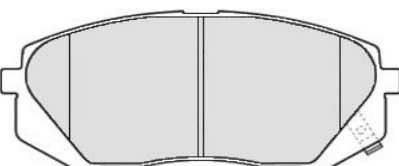

138 x 61 x 16mm
Hyundai, Kia

PP962

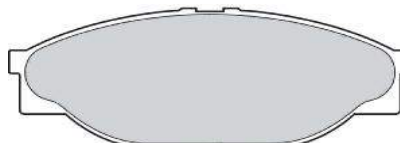

140 x 55 x 16mm
Toyota

PP963



110.5 x 37.5 x 14.5mm
Subaru

BRAKE PADS

PP965

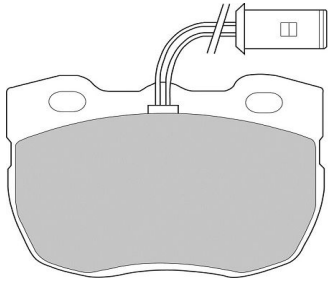

105 x 72 x 18mm
Land Rover

PP967

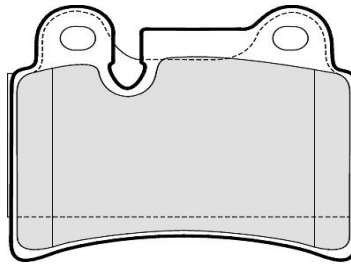

87 x 70 x 17mm
Volkswagen

PP968

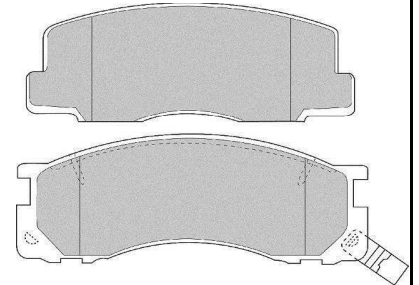

128/137 x 52/55 x 15mm
Toyota

PP969



120 x 44 x 15mm
Toyota

PP970

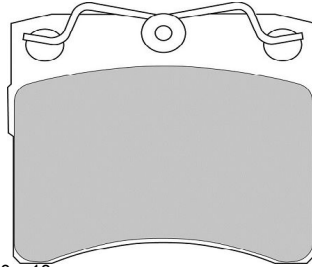

92 x 80 x 18mm
Volkswagen

PP971

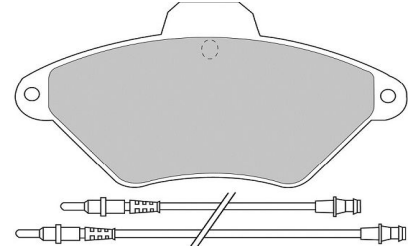

131 x 69 x 16mm
Citroen

PP972

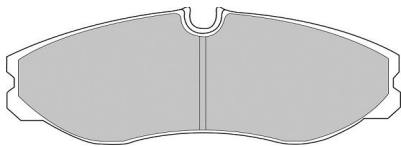

145 x 55 x 15mm
Ford, Nissan

PP973

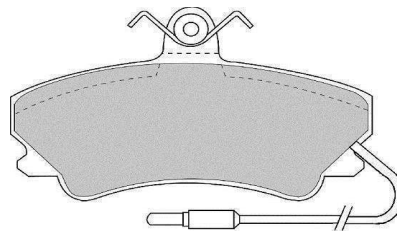

110 x 68 x 18mm
Renault

PP974

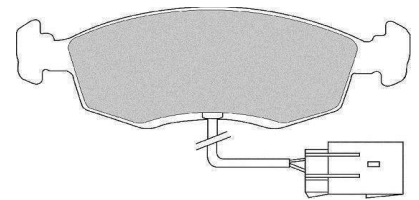

151 x 53 x 18mm
Ford

PP975

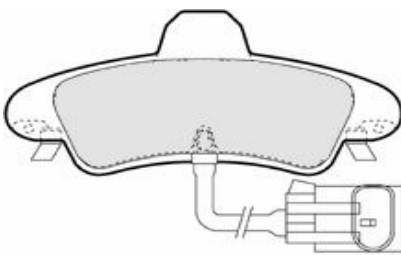

116 x 53.5 x 15mm
Ford

PP976

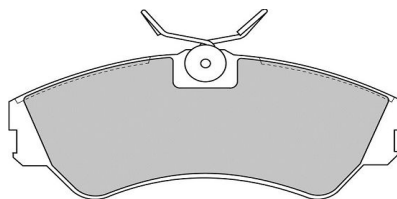

130 x 55 x 19mm
Volkswagen

PP977

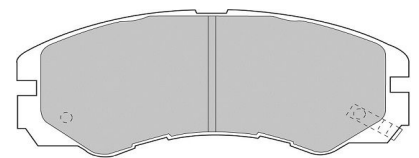

138 x 60 x 16mm
Isuzu

PP978

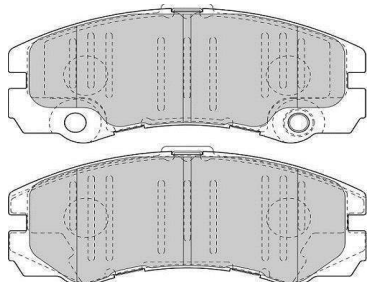

138 x 59 x 18mm
Vauxhall

PP979

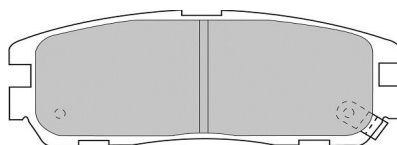

110 x 42 x 16mm
Isuzu, Vauxhall

PP980

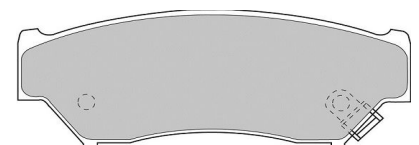

117 x 45 x 15mm
Suzuki

BRAKE PADS

PP981

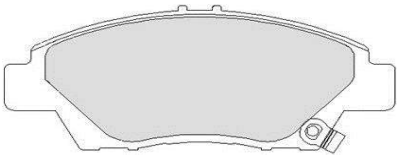

136.5 x 56.5 x 16.5mm

Honda

PP982

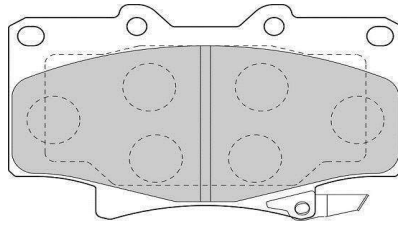

119 x 72 x 15mm

Toyota

PP983

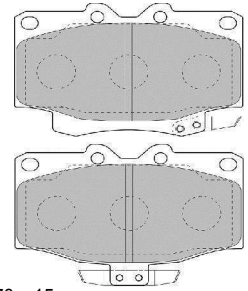

107 x 74/70 x 15mm

Toyota

PP984

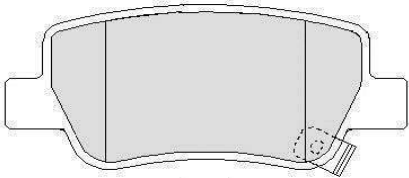

109 x 50 x 16.5mm

Toyota

PP985



131.5 x 59.5 x 19mm

Vauxhall

PP986

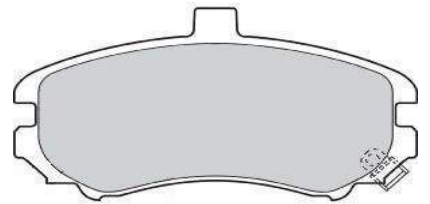

131 x 70 x 17mm

Hyundai

PP987

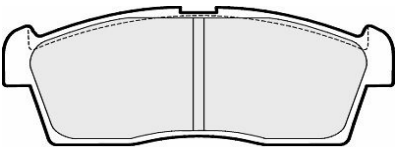

108 x 42 x 15mm

Suzuki

PP988

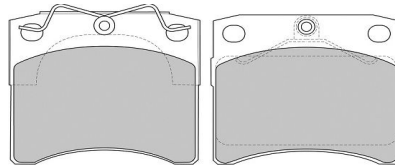

92 x 80 x 18mm

Volkswagen

PP989

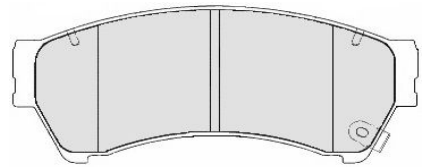

136.5 x 59 x 17.5mm

Mazda

PP990

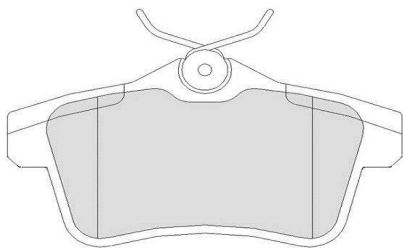

104 x 56 x 17mm

Citroën, Peugeot

PP991

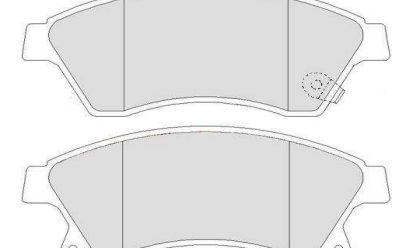

148 x 60 x 19mm

Chevrolet, Vauxhall

PP992

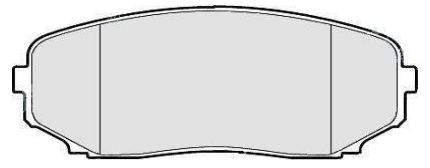

139 x 58 x 18mm

Mazda

PP993

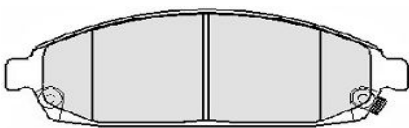

176 x 57 x 19mm

Jeep

PP994

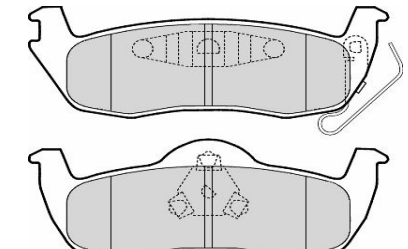

142 x 49/53 x 18mm

Jeep

PP995



146.5 x 53 x 17mm

Toyota

BRAKE PADS

PP996

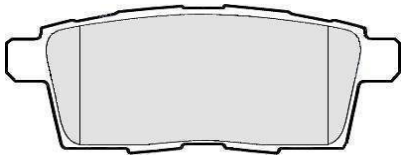

110.5 x 46 x 18.5mm

Mazda

PP997

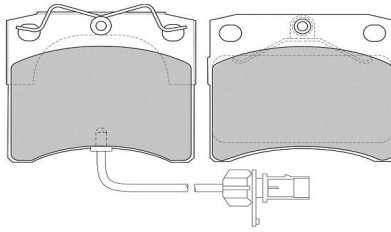

92 x 80 x 18mm

Volkswagen

PP998

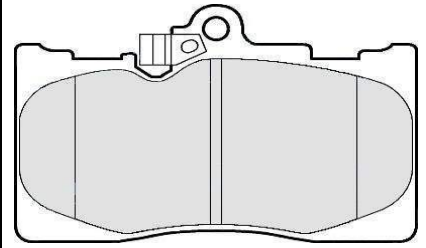

118.5 x 77.5 x 17mm

Lexus

PP999

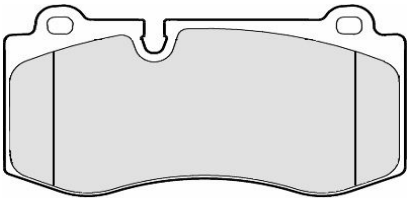

141.5 x 76 x 17.5mm

Mercedes

PP1000

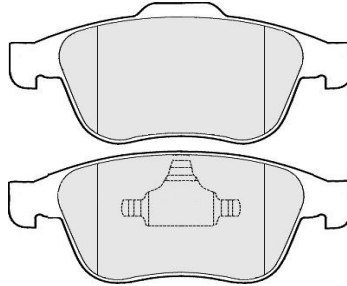

155 x 65/59.5 x 18mm

Renault

PP1001

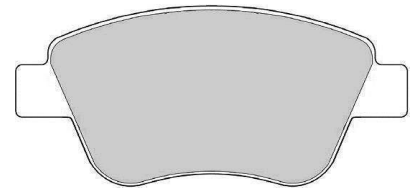

106 x 46.5 x 16.5mm

Renault

PP1002

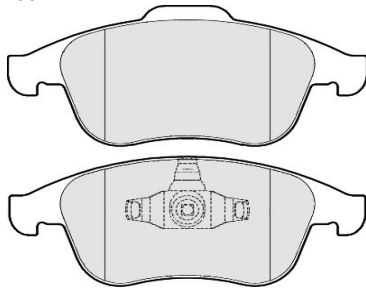

155 x 68/63 x 18.5mm

Renault

PP1003

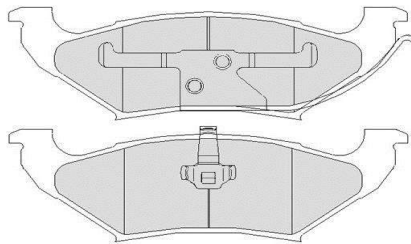

156 x 49 x 16mm

Chrysler

PP1004

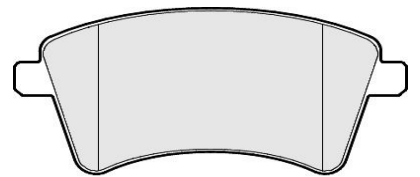

131 x 62 x 19mm

Renault

PP1005



95 x 44 x 16mm

Renault

PP1006

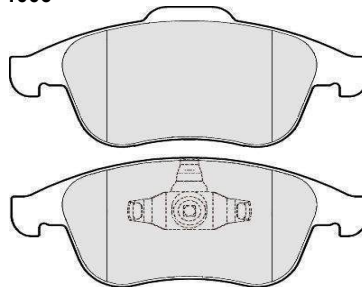

155/156.5 x 68/63 x 18.5mm

Renault

PP1007

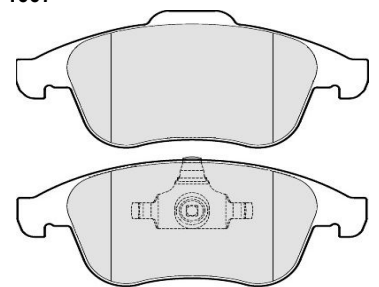

155/156.5 x 68/63 x 18.5mm

Renault

PP1008



149 x 61 x 17mm

Ssangyong

PP1009

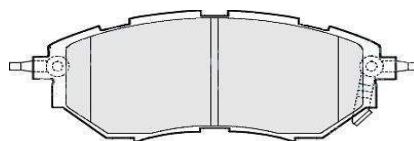

157 x 63.5 x 18mm

Subaru/Toyota

PP1010

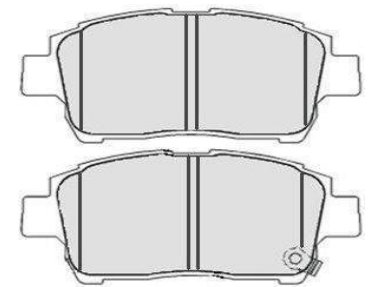

116.5 x 51.5 x 16.5mm

Toyota

BRAKE PADS

PP1011

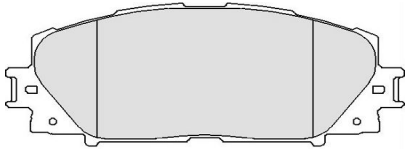

123 x 49.5 x 15.5mm

Toyota

PP1012

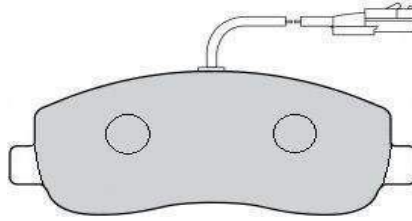

163.5 x 64.5 x 18mm

Renault, Vauxhall

PP1013

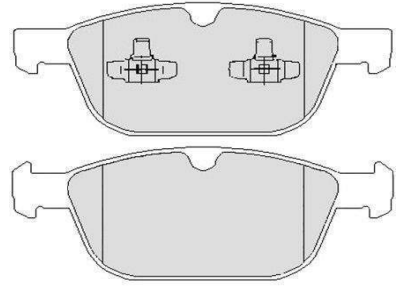

195 x 76.5 x 20/19.5mm

Volvo

PP1014

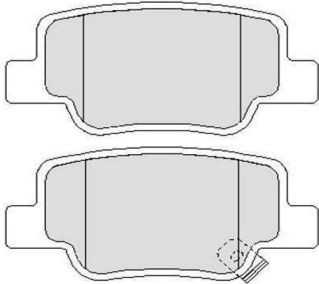

102 x 49 x 17mm

Toyota

PP1015

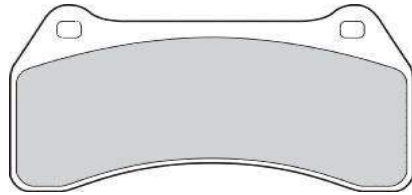

145mm x 75.5 x 15.5mm

Jaguar

PP1016

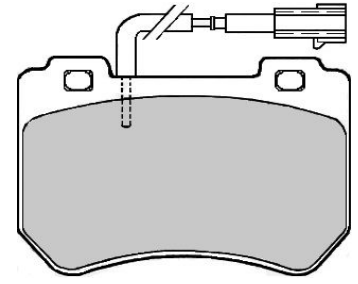

109.5 x 80.5 x 16mm

Alfa Romeo

PP1023

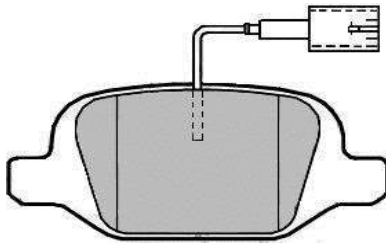

95.5 x 44 x 14mm

Fiat

PP1025

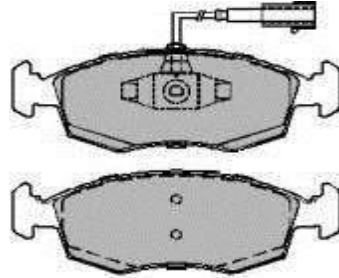

149 x 53 x 17.5mm

Fiat

PP1026

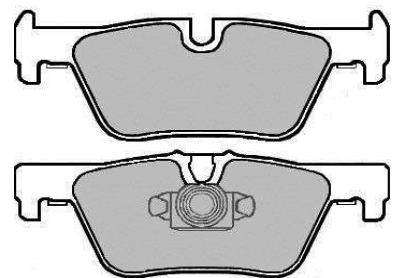

149 x 53 x 17.5mm

BMW

